

# **Performance Series**

## **Embedded DVR**

**HRG4X  
HRG41X  
HRG45X**

**HRG8X  
HRG81X  
HRG82X**

**HRG16X  
HRG161X  
HRG162X  
HRG164X**

## **User Guide**







# **User Guide**



---

## Cautions and Warnings

---

	<b>CAUTION</b> RISK OF ELECTRIC SHOCK DO NOT OPEN		 THIS SYMBOL INDICATES THAT DANGEROUS VOLTAGE CONSTITUTING A RISK OF ELECTRIC SHOCK IS PRESENT WITHIN THE UNIT.
CAUTION: TO REDUCE THE RISK OF ELECTRIC SHOCK, DO NOT REMOVE THE COVER. NO USER-SERVICEABLE PARTS INSIDE. REFER SERVICING TO QUALIFIED SERVICE PERSONNEL.			 THIS SYMBOL INDICATES THAT IMPORTANT OPERATING AND MAINTENANCE INSTRUCTIONS ACCOMPANY THIS UNIT.

Installation and servicing should be performed only by qualified and experienced technicians to conform to all local codes and to maintain your warranty.

**CAUTION** 12 VDC models require the use of CSA Certified/UL Listed Class 2 power adapters to ensure compliance with electrical safety standards.

---

## Regulatory Statements

---

**Information to the User:** This equipment has been tested and found to comply with the limits for a Class A digital device. Pursuant to part 15 of the FCC Rules, these limits are designed to provide reasonable protection against harmful interference in a commercial environment. This equipment generates, uses, and can radiate radio frequency energy and, if not installed and used in accordance with the instruction manual, may cause harmful interference to radio communications. Operation of this equipment in a residential area is likely to cause harmful interference, in which case the user will be required to correct the interference at his own expense.

**CAUTION** Changes or modifications not expressly approved by the party responsible for compliance could void the user's authority to operate the equipment.

### Canadian Compliance Statement

This Class A digital apparatus complies with Canadian ICES-003.  
Cet appareil numérique de la Classe A est conforme à la norme NMB-003 du Canada.

### North America

The equipment supplied with this guide conforms to UL 60950-1 and CSA C22.2 No. 60950-1.

## Europe

The manufacturer declares that the equipment supplied is compliant with the essential requirements of the EMC directive 2004/108/EC, conforming to the requirements of standards EN 55022 for emissions, EN 50130-4 for immunity, and EN 60950 for electrical equipment safety.

## Waste Electrical and Electronic Equipment (WEEE)



**Correct Disposal of this Product** (applicable in the European Union and other European countries with separate collection systems).

This product should be disposed of, at the end of its useful life, as per applicable local laws, regulations, and procedures.

---

## Safety Instructions

---

**BEFORE OPERATING OR INSTALLING THE UNIT, READ AND FOLLOW ALL INSTRUCTIONS.**

**AFTER INSTALLATION, retain the safety and operating instructions for future reference**

1. **HEED WARNINGS** - Adhere to all warnings on the unit and in the operating instructions.
2. **INSTALLATION**
  - Install in accordance with the manufacturer's instructions.
  - Installation and servicing should be performed only by qualified and experienced technicians to conform to all local codes and to maintain your warranty.
  - Do not install the unit in an extremely hot or humid location, or in a place subject to dust or mechanical vibration. The unit is not designed to be waterproof. Exposure to rain or water may damage the unit.
  - Any wall or ceiling mounting of the product should follow the manufacturer's instructions and use a mounting kit approved or recommended by the manufacturer.
3. **POWER SOURCES** - This product should be operated only from the type of power source indicated on the marking label. If you are not sure of the type of power supplied to your facility, consult your product dealer or local power company.
4. **HEAT** - Situate away from items that produce heat or are heat sources such as radiators, heat registers, stoves, or other products (including amplifiers).
5. **WATER AND MOISTURE** - Do not use this unit near water or in an unprotected outdoor installation, or any area classified as a wet location.
6. **MOUNTING SYSTEM** - Use only with a mounting system recommended by the manufacturer, or sold with the product.
7. **ATTACHMENTS** - Do not use attachments not recommended by the product manufacturer as they may result in the risk of fire, electric shock, or injury to persons.
8. **ACCESSORIES** - Only use accessories specified by the manufacturer.
9. **CLEANING** - Do not use liquid cleaners or aerosol cleaners. Use a damp cloth for cleaning.

10. **SERVICING** - Do not attempt to service this unit yourself as opening or removing covers may expose you to dangerous voltage or other hazards. Refer all servicing to qualified service personnel.
11. **REPLACEMENT PARTS** - When replacement parts are required, be sure the service technician has used replacement parts specified by the manufacturer or have the same characteristics as the original part. Unauthorized substitutions may result in fire, electric shock or other hazards.

---

## Warranty and Service

---

Subject to the terms and conditions listed on the Product warranty, during the warranty period Honeywell will repair or replace, at its sole option, free of charge, any defective products returned prepaid.

In the event you have a problem with any Honeywell product, please call Customer Service at 1.800.323.4576 for assistance or to request a **Return Merchandise Authorization (RMA)** number.

Be sure to have the model number, serial number, and the nature of the problem available for the technical service representative.

Prior authorization must be obtained for all returns, exchanges, or credits. **Items shipped to Honeywell without a clearly identified Return Merchandise Authorization (RMA) number may be refused.**





# Contents

<b>About This Document</b> . . . . .	<b>19</b>
Overview of Contents . . . . .	19
Related Documents . . . . .	20
Typographical Conventions . . . . .	20
<b>1 Introduction</b> . . . . .	<b>23</b>
Overview . . . . .	23
Product Features . . . . .	23
System Diagram . . . . .	25
Operating the HRG DVR . . . . .	26
Front Panel . . . . .	26
Using the IR Remote Control . . . . .	29
Using a USB Mouse . . . . .	30
Using the Virtual Keyboard . . . . .	31
Rear Panel . . . . .	31
<b>2 Getting Started</b> . . . . .	<b>35</b>
Starting and Shutting Down the HRG DVR . . . . .	35
Starting the HRG DVR . . . . .	35
Shutting Down the HRG DVR . . . . .	36
Rebooting and Locking the HRG DVR . . . . .	36
Using the Setup Wizard . . . . .	36
Setting the Date and Time . . . . .	42
<b>3 Live View</b> . . . . .	<b>43</b>
On-screen Display in Live View . . . . .	43
Live View Icons . . . . .	43
Operating Live View . . . . .	44
Using the Mouse in Live View . . . . .	44
Using the Digital Zoom . . . . .	45
Configuring the Live View Display . . . . .	46
Setting the Camera Order . . . . .	47
<b>4 Recording Settings</b> . . . . .	<b>49</b>
Configuring Recording Settings . . . . .	49
Initializing Recording Settings . . . . .	49
Scheduling Recording . . . . .	51
Starting a Manual Recording . . . . .	52
Protecting Recorded Files . . . . .	53
Locking and Unlocking Recorded Files . . . . .	53
Setting the Hard Drive to Read-Only . . . . .	54
<b>5 Playback</b> . . . . .	<b>57</b>
Video Playback . . . . .	57
Playback Interface . . . . .	57
Playback by Search . . . . .	58
Playback in Live View Mode . . . . .	59
Playback by System Log . . . . .	60
Playback Frame-by-Frame . . . . .	61
Digital Zoom . . . . .	61

<b>6</b>	<b>Backup</b>	<b>63</b>
	Backing Up Recorded Files	63
	Exporting Files	63
	Exporting Video Clips	65
	Managing Backup Devices	66
<b>7</b>	<b>Alarm Settings</b>	<b>69</b>
	Configuring Alarms	69
	Motion Detection Alarm	69
	Sensor Alarm Settings	72
	Manual Alarm Triggering	75
	Video Loss Detection	76
	Video Tampering Detection	78
	Exception Settings	80
	Understanding Exception Trigger Options	81
<b>8</b>	<b>Network Settings</b>	<b>83</b>
	Configuring Network Settings	83
	Configuring General System Settings	83
	Configuring PPPoE Settings	84
	Configuring DDNS	86
	Configuring NTP Server Settings	86
	Configuring Remote Alarm Host Settings	87
	Configuring Multicast	88
	Configuring Server and HTTP Ports	89
	Configuring Email	89
<b>9</b>	<b>PTZ Control</b>	<b>91</b>
	Navigating the PTZ Menu	91
	Configuring PTZ Settings	92
	Setting PTZ Presets, Patrols and Patterns	93
	Understanding PTZ Controls	93
	Customizing Presets	93
	Customizing Patrols	94
	Customizing Patterns	96
<b>10</b>	<b>Camera Management</b>	<b>97</b>
	OSD Settings	97
	Image Settings	98
	Privacy Mask Settings	99
<b>11</b>	<b>Hard Drive Management</b>	<b>101</b>
	Managing Hard Drives	101
	Initializing Hard Drives	101
	Setting HDD Groups	102
	Setting HDD Status	102
	Checking HDD Status	103
	Configuring HDD Alarms	105
<b>12</b>	<b>HRG DVR Management</b>	<b>107</b>
	Configuring System Settings	107
	Configuring General Settings	107
	Configuring Advanced Settings	108
	Setting the RS-232 Port	109
	Managing User Accounts	110
	Adding a New User	110
	Deleting a User	113
	Modifying a User	114
	Managing the System	114
	Importing and Exporting the Configuration File	114
	Updating the System Firmware	115
	Restoring the Default Settings	117
	Viewing the System Information	118
	Viewing the System Log	118

**Appendix A Glossary . . . . . 121**

**Appendix B Solutions . . . . . 123**

Troubleshooting the HRG DVR. . . . . 123

Troubleshooting the IR Remote Control . . . . . 125

**Appendix C Specifications . . . . . 127**

    Dimensions . . . . . 129

**Index . . . . . 131**



# Figures

Figure 1-1	System Diagram (4-Channel HRG DVR shown)	26
Figure 1-2	4-Channel HRG Front Panel	27
Figure 1-3	8-Channel/16-Channel HRG Front Panel	28
Figure 1-4	IR Remote Control	29
Figure 1-5	Virtual Keyboard	31
Figure 1-6	4-Channel HRG Rear Panel Connections and Switches	31
Figure 2-1	Shutdown Menu	36
Figure 2-2	Setup Wizard	37
Figure 2-3	User Permission Window	37
Figure 2-4	Entering the HDD Management Window	38
Figure 2-5	HDD Management Window	38
Figure 2-6	Entering the Record Settings Window	39
Figure 2-7	Schedule Tab	39
Figure 2-8	Entering a New Recording Schedule	40
Figure 2-9	Copying a Schedule	40
Figure 2-10	Entering the Network Settings Window	41
Figure 2-11	Network Settings Window	41
Figure 2-12	Setting the Date and Time	42
Figure 3-1	Live View Shortcut Menu	44
Figure 3-2	Digital Zoom	45
Figure 3-3	Display Settings Menu	46
Figure 3-4	Camera Order Settings	47
Figure 4-1	General Record Settings Menu	49
Figure 4-2	More Record Settings	50
Figure 4-3	Advanced Record Settings	51
Figure 4-4	Schedule Record Settings Menu	51
Figure 4-5	Manual Record Menu	52
Figure 4-6	Video Search Menu	53
Figure 4-7	Video Search Result List	54
Figure 4-8	HDD Management Menu	54
Figure 4-9	HDD Property Settings Menu	55
Figure 5-1	Playback Interface	57
Figure 5-2	Playback Control Panel	58
Figure 5-3	Video Search Menu	58
Figure 5-4	Playback Interface	59
Figure 5-5	Playback Interface	59
Figure 5-6	Log Search Menu	60
Figure 5-7	Digital Zoom in Playback Mode	61

Figure 6-1	Record Backup Menu . . . . .	63
Figure 6-2	Video Search Results . . . . .	64
Figure 6-3	Export Menu . . . . .	64
Figure 6-4	Backup Progress Screen . . . . .	65
Figure 6-5	Export Successful Screen . . . . .	65
Figure 6-6	Save Video Clips Prompt . . . . .	66
Figure 6-7	Export Menu . . . . .	66
Figure 7-1	Camera Settings Menu . . . . .	69
Figure 7-2	Advanced Camera Settings - Motion Detection . . . . .	70
Figure 7-3	Motion Detection Area Settings Interface . . . . .	70
Figure 7-4	Motion Detection Sensitivity Settings . . . . .	71
Figure 7-5	Exception Handle Menu . . . . .	71
Figure 7-6	Schedule Settings . . . . .	72
Figure 7-7	Handle Settings . . . . .	72
Figure 7-8	Alarm Settings Menu . . . . .	73
Figure 7-9	Alarm Input Settings Menu . . . . .	73
Figure 7-10	Alarm Input Handle Menu . . . . .	74
Figure 7-11	Alarm Output Interface . . . . .	74
Figure 7-12	Alarm Output Settings . . . . .	75
Figure 7-13	Manual Alarm Menu . . . . .	75
Figure 7-14	Camera Settings Menu . . . . .	76
Figure 7-15	Advanced Camera Settings - Video Loss Detection . . . . .	77
Figure 7-16	Schedule Settings . . . . .	77
Figure 7-17	Handle Settings . . . . .	78
Figure 7-18	Camera Settings Menu . . . . .	78
Figure 7-19	Advanced Camera Settings - Tamper Detection . . . . .	79
Figure 7-20	Schedule Settings . . . . .	79
Figure 7-21	Handle Settings . . . . .	80
Figure 7-22	Exception Menu . . . . .	81
Figure 8-1	Network Settings Menu . . . . .	83
Figure 8-2	Network Status . . . . .	84
Figure 8-3	Advanced Network Settings Menu . . . . .	85
Figure 8-4	PPPoE Settings . . . . .	85
Figure 8-5	DDNS Settings Menu . . . . .	86
Figure 8-6	NTP Settings Menu . . . . .	87
Figure 8-7	Host/Others Menu . . . . .	88
Figure 8-8	Host/Others Menu . . . . .	88
Figure 8-9	Host/Others Menu . . . . .	89
Figure 8-10	Email Settings Menu . . . . .	90
Figure 9-1	PTZ Menu . . . . .	91
Figure 9-2	PTZ Settings Menu . . . . .	92
Figure 9-3	PTZ Control Panel . . . . .	93
Figure 9-4	Preset Management Menu . . . . .	94
Figure 9-5	Patrol Management Menu . . . . .	94
Figure 9-6	Patrol Configuration Menu . . . . .	95
Figure 9-7	Patrol Management Menu . . . . .	96
Figure 9-8	Pattern Management Menu . . . . .	96
Figure 10-1	Camera Settings Menu . . . . .	97
Figure 10-2	Advanced Camera Settings Menu . . . . .	98

Figure 10-3	Image Settings . . . . .	98
Figure 10-4	Advanced Camera Settings Menu . . . . .	99
Figure 10-5	Setting Mask Area . . . . .	99
Figure 11-1	HDD Management Menu . . . . .	101
Figure 11-2	HDD Group Settings Menu . . . . .	102
Figure 11-3	HDD Property Settings Menu . . . . .	103
Figure 11-4	Log Search Menu . . . . .	104
Figure 11-5	Log Search Results . . . . .	104
Figure 11-6	HDD SMART Information . . . . .	105
Figure 11-7	HDD SMART Menu . . . . .	105
Figure 11-8	Exception Menu, HDD Error . . . . .	106
Figure 12-1	General Settings Menu . . . . .	107
Figure 12-2	More Settings Menu . . . . .	108
Figure 12-3	RS-232 Settings Menu . . . . .	109
Figure 12-4	User Settings Menu . . . . .	110
Figure 12-5	Add User Menu . . . . .	111
Figure 12-6	Permission Settings Menu . . . . .	111
Figure 12-7	Network Permission Settings Menu . . . . .	112
Figure 12-8	Camera Permission Settings Menu . . . . .	113
Figure 12-9	Modify User Menu . . . . .	114
Figure 12-10	Import/Export Configuration Menu . . . . .	115
Figure 12-11	Firmware Update Menu . . . . .	116
Figure 12-12	FTP Firmware Update . . . . .	116
Figure 12-13	Default Settings Menu . . . . .	117
Figure 12-14	System Information . . . . .	118
Figure 12-15	Log Search Menu . . . . .	119
Figure 12-16	Log Search Results . . . . .	119
Figure 12-17	Log Search Export Menu . . . . .	120





# Tables

Table 1-1	4-Channel HRG Front Panel Controls and Indicators . . . . .	27
Table 1-2	IR Remote Control . . . . .	29
Table 1-3	Mouse Controls . . . . .	30
Table 1-4	Virtual Keyboard Controls . . . . .	31
Table 1-5	4-Channel HRG Rear Panel Connections and Switches . . . . .	32
Table 1-6	8-Channel/16-Channel Rear Panel Connections and Switches . . . . .	33



# About This Document

This document covers how to install and operate HRG Performance Series DVRs.

This document is intended for system integrators, installers, and end-user operators.

---

## Overview of Contents

---

This document contains the following chapters and appendixes:

- [Chapter 1, Introduction](#), introduces the HRG Performance Series, including the main features, typical setup, front panel controls, IR remote control, mouse, virtual keyboard controls, and the back panel connections.
- [Chapter 2, Getting Started](#), explains how to start up and shut down the DVR, how to reboot and lock the DVR, how to use the Setup Wizard for initial setup, and how to set the date and time.
- [Chapter 3, Live View](#), describes the Live View on-screen display, how to use the mouse to control Live View, how to zoom in Live View, and how to configure the Live View display.
- [Chapter 4, Recording Settings](#), explains how to configure recording settings and how to protect recorded files.
- [Chapter 5, Playback](#), describes the playback interface, explains how to search recordings and the system log, and how to play back recorded video.
- [Chapter 6, Backup](#), explains how to export files and video clips, and how to manage backup devices.
- [Chapter 7, Alarm Settings](#), explains how to configure alarms, including motion detection, sensors, video loss and video tampering detection, and how to managed exception settings.
- [Chapter 8, Network Settings](#), explains how to configure network settings, including email notification.
- [Chapter 9, PTZ Control](#), explains PTZ configuration, including PTZ presets, patrols, and patterns.
- [Chapter 10, Camera Management](#), explains OSD settings, image settings, and privacy mask settings.
- [Chapter 11, Hard Drive Management](#), explains how to configure and manage hard drives.
- [Chapter 12, HRG DVR Management](#), explains how to configure system settings such as language, time zone, date and time, mouse speed, and password; how to configure the RS-232 port, how to manage user accounts and system configuration; how to update the firmware; how to restore default settings; how to view system information and system logs.

- [Appendix A, Glossary](#), explains commonly used terms in this guide.
- [Appendix B, Solutions](#), provides possible solutions for resolving system malfunctions that may occur from time to time.
- The [Index](#) provides a searchable list for easy access to the document.

---

## Related Documents

---

This document is a necessary prerequisite for understanding HRG Performance Series DVRs. For more information, please refer to the following documents:

Document title	Part number	Description
<i>Multi-Site 4200 Remote Viewing Software User Guide</i>	800-12064	Describes how to use the remote viewing software for HRG Performance Series DVRs.
<i>HRG App for Apple iOS Devices User Guide</i>	800-12168	Describes how to remotely access HRG Performance Series DVRs via a wireless network connection.
<i>HRG App for Android Devices User Guide</i>	800-12218	Describes how to remotely access HRG Performance Series DVRs via a wireless network connection.

---

## Typographical Conventions

---

This document uses the following typographical conventions:

Font	What it represents	Example
Helvetica	Keys on the keyboard	Press <b>Ctrl+C</b>
Lucida	Values of editable fields that are mentioned in the body text of the document for reference purposes, but do not need to be entered as part of a procedure	The <b>Time from</b> field can be set to Hours:Minute:Seconds.
	Text strings displayed on the screen Syntax	The message Unauthorized displays. (object) entered
<b>Swiss721 BT Bold</b>	Words or characters that you must type. The word “enter” is used if you must type text and then press the Enter or Return key.	Enter the <b>password</b> .
	Menu titles and other items you select	Double-click <b>Open</b> from the <b>File</b> menu.
	Buttons you click to perform actions	Click <b>Exit</b> to close the program.

Font	What it represents	Example
<i>Italic</i>	Placeholders: words that vary depending on the situation	Enter your <i>user name</i> .
	Cross-reference to external source	Refer to the <i>System Administrator Guide</i> .
	Cross-reference within document	See <i>Chapter 2, Installation</i> .



# 1

## Introduction

This chapter introduces the Honeywell HRG 4-Channel, 8-Channel, and 16-Channel Performance Series DVRs and provides an overview of how to operate the HRG DVR using various methods.

---

## Overview

---

Developed using the latest technology, the Honeywell HRG Performance Series DVRs (HRG DVRs) combine the latest in advanced H.264 video encoding and decoding technologies to deliver high performance, rock-solid reliability, and longer recording times.

The Honeywell HRG DVRs can be used either as standalone video surveillance products or used to build a powerful surveillance network. This flexibility makes them perfect for small business applications.

## Product Features

### Feature Overview

- 4, 8, or 16 video inputs (model dependent).
- H.264 video compression with excellent reliability and superior definition.
- 4 audio inputs, 1 audio output.
- IR remote controller and mouse included
- Independent video encoding parameters, including frame rate, resolution, bit rate, and video quality.
- Remote access from iPhone and Android devices.
- Multi-site software.
- Recording rates up to 120 (4-channel), 240 (8-channel) and 480 (16-channel) ips @ 4CIF resolution.
- PTZ dome control.

## Local Monitoring Features

- Up to 1280 × 1024 resolution for VGA output display.
- Simultaneous VGA and CVBS output.
- Multi-camera video live view, with an adjustable camera order.
- Group switch, manual switch, and automatic cycles modes that are selectable for video live view, with a configurable auto-cycle period.
- Digital zoom in live mode.
- Shield of assigned channels for live view.
- Privacy masking support.
- Multiple PTZ protocols support, including the setting and call up of presets, patrols, and patterns.
- Video image zoom-in by clicking the mouse and tracing by dragging the mouse in PTZ control mode.

## Hard Disk Drive Management Features

- S.M.A.R.T. technology.
- HDD standby function.

## Recording Features

- Cycle and non-cycle recording mode.
- Normal and event video encoding parameters.
- Multiple recording types, including manual, normal, alarm, motion, motion/alarm, and motion + alarm recording.
- Eight recording time periods, with separate recording types.
- Pre-record and post-record time intervals for alarm and motion detection, and pre-record time intervals for scheduled and manual recording.
- Lock and unlock video files.
- HDD can be set to read-only.
- Video data search and playback by channel number, recording type, and time.
- Digital zoom function in playback mode.
- Pause, fast forward play, slow play, skip forward, and skip backward available during playback.
- Up to 4/8/16-channel synchronous playback.

## Backup Features

- Back up recorded files to a USB or SATA device.
- Bunch backup by file or by time.
- Recorded files edited for backup in playback.
- Management and maintenance for backup devices.



## Alarm and Exception Features

- Configurable arming time for alarm in/out.
- Support of various exception alarm types, including: alarms for video loss, motion detection, video tampering, unmatched video in/out format, illegal access, network disconnection, IP conflict, hard disk error, and hard disk full.
- Support of various exception alarm handling methods, including: pop-up alarm image on the monitor, audible warnings, surveillance center notifications, alarm output triggers, and send emails.
- Auto recovery from exceptions.

## Other Features

- Use a mouse or the IR remote control to control the HRG DVR.
- Three-level user management. Each user has individual operating permission for the HRG DVR and cameras.
- Powerful recording and searching of operation, alarm, and exception logs.
- Import/export of device configuration files.

## Network Features

- 10M/100M adaptive network interface.
- TCP/IP protocol suites, PPPoE, DHCP, DNS, DDNS, NTP, SADP protocols.
- Unicast and multicast supported; TCP and UDP protocols applicable in unicast transmission.
- Remote search, playback and download, lock/unlock of video files.
- Breakpoint resume support.
- Remote access and configuration of parameters; remote import/export of device configuration parameters.
- Remote access of device running status, system log, and alarm status.
- Remote formatting of hard disk, upgrade, reboot/shutdown, and other system maintenance operations.
- Event alarm and exceptions upload to a remote management host.
- Remote video image capture in JPEG format.
- Remote PTZ control.
- Voice talk and broadcast.
- Built-in WEB Server.

## System Diagram

Connect your HRG DVR as shown in [Figure 1-1](#).

Figure 1-1 System Diagram (4-Channel HRG shown)

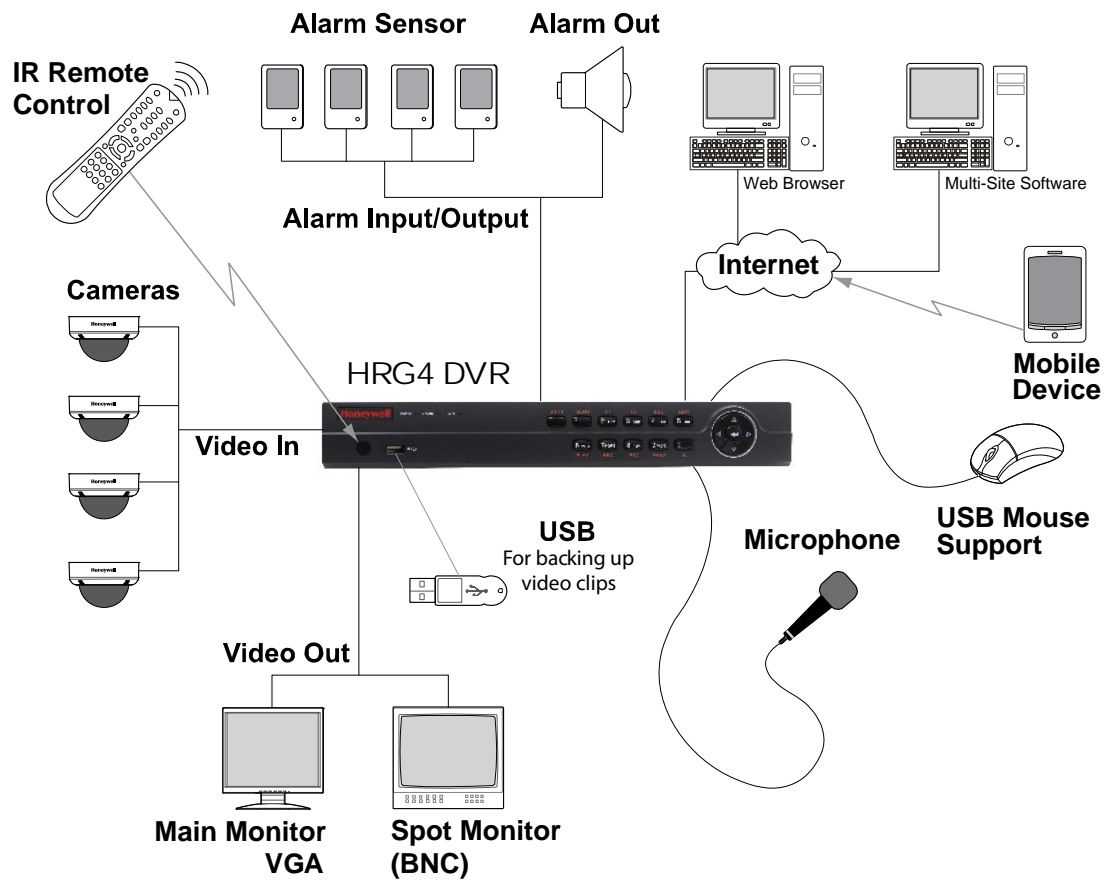

---

## Operating the HRG DVR

---

You can use the following tools to navigate and operate your HRG DVR.

- the front panel controls (see [Front Panel on page 26](#))
- the IR (Infrared) remote (see [Using the IR Remote Control on page 29](#))
- a mouse (see [Using a USB Mouse on page 30](#))
- the virtual keyboard (see [Using the Virtual Keyboard on page 31](#))

### Front Panel

Familiarize yourself with the front panel controls for your HRG DVR.

## 4-Channel HRG Front Panel

Figure 1-2 4-Channel HRG Front Panel



Table 1-1 4-Channel HRG Front Panel Controls and Indicators

Position	Control/Indicator	Function
1	<b>IR Receiver</b>	Sensor for IR Remote Controller.
2	<b>USB Port</b>	Connection for a USB mouse or USB flash memory device.
3	<b>Status Indicators</b>	
	POWER	Turns green when the HRG DVR is on.
	STATUS	Illuminates when the compound key switches to numeric/letter input mode.
	Tx/Rx	Flickers green when the network connection is functioning normally.
4	<b>SHIFT</b>	Switches the compound keys functions from inputting the numeric/letter values to the functional controls.
5	<b>Compound Buttons</b>	
	1/MENU	Enter number "1"; Access the main menu.
	2/ABC/F1	Enter number "2" or letters "A", "B", "C"; The F1 button when used in a list field will select all items on the list. In PTZ Control mode, it will turn on/off PTZ light.
	3/DEF/F2	Enter number "3" or letters "D", "E", "F"; The F2 button is used to cycle through tab pages. It will also bring up the Channel and OSD Position settings.
	4/GHI/ESC	Enter number "4" or letters "G", "H", "I"; Exit and back to the previous menu.
	5/JKL/EDIT	Enter number "5" or letters "J", "K", "L"; Delete characters before cursor; Select the check box and ON/OFF switch; Start/stop record clipping in playback.
	6/MNO/PLAY	Enter number "6" or letters "M", "N", "O"; Playback, for direct access to playback interface.
	7/PQRS/REC	Enter number "7" or letters "P", "Q", "R", "S"; Manual record, for direct access to manual record interface; manually enable/disable record.
	8/TUV/PTZ	Enter number "8" or letters "T", "U", "V"; Access to PTZ control interface.
	9/WXYZ/PREV	Enter number "9" or letters "W", "X", "Y", "Z"; Multi-camera display in live view.
	0/A	Enter number "0"; Switch between input methods (upper and lowercase alphabet, symbols and numeric input).
6	<b>Control Buttons</b>	<p><b>Directional buttons:</b> In menu mode, the direction buttons are used to navigate between different fields and items and select setting parameters. In playback mode, the <b>Up</b> and <b>Down</b> buttons are used to speed up and slow down record play, and the <b>Left</b> and <b>Right</b> buttons are used to select the recording 30s forwards or backwards. In Live View mode, these buttons can be used to cycle through channels.</p> <p><b>Enter:</b> The <b>Enter</b> button is used to confirm selection in the Menu mode; or used to select check box fields and <b>ON/OFF</b> switch. In playback mode, it can be used to play or pause the video. In single-frame play mode, pressing the <b>Enter</b> button advances the video by a single frame. And in auto sequence live view mode, the buttons can be used to pause / resume auto sequence.</p>

## 8-Channel/16-Channel HRG Front Panel

Figure 1-3 8-Channel/16-Channel HRG Front Panel



Position	Control/Indicator	Function
1	<b>IR Receiver</b>	Sensor for IR Remote Controller.
2	<b>USB Port</b>	Connection for a USB mouse or USB flash memory device.
3	<b>Status Indicators</b>	
	POWER	Turns green when the HRG DVR is on.
	READY	Turns green when the device is running normally.
	STATUS	Illuminates when the compound key switches to numeric/letter input mode.
	ALARM	Turns red when there is a sensor alarm occurring.
	HDD	Flickers red when the HDD is reading or writing.
	Tx/Rx	Flickers green when the network connection is functioning normally.
4	<b>SHIFT</b>	Switches the compound keys functions from inputting the numeric/letter values to the functional controls.
5	<b>Compound Buttons</b>	
	1/MENU	Enter number "1"; Access the main menu.
	2/ABC/F1	Enter number "2" or letters "A", "B", "C"; The F1 button when used in a list field will select all items on the list. In PTZ Control mode, it will turn on/off PTZ light.
	3/DEF/F2	Enter number "3" or letters "D", "E", "F"; The F2 button is used to cycle through tab pages. It will also bring up the Channel & OSD Position settings.
	4/GHI/ESC	Enter number "4" or letters "G", "H", "I"; Exit and back to the previous menu.
	5/JKL/EDIT	Enter number "5" or letters "J", "K", "L"; Delete characters before cursor; Select the check box and ON/OFF switch; Start/stop record clipping in playback.
	6/MNO/PLAY	Enter number "6" or letters "M", "N", "O"; Playback, for direct access to playback interface.
	7/PQRS/REC	Enter number "7" or letters "P", "Q", "R", "S"; Manual record, for direct access to manual record interface; manually enable/disable record.
	8/TUV/PTZ	Enter number "8" or letters "T", "U", "V"; Access to PTZ control interface.

Position	Control/Indicator	Function
	9/WXYZ/PREV	Enter number "9" or letters "W", "X", "Y", "Z"; Multi-camera display in live view.
	0/A	Enter number "0"; Switch between input methods (upper and lowercase alphabet, symbols and numeric input).
6	Control Buttons	<p><b>Directional buttons:</b> In menu mode, the direction buttons are used to navigate between different fields and items and select setting parameters. In playback mode, the <b>Up</b> and <b>Down</b> buttons are used to speed up and slow down record play, and the <b>Left</b> and <b>Right</b> buttons are used to select the recording 30s forwards or backwards. In Live View mode, these buttons can be used to cycle through channels.</p> <p><b>Enter:</b> The <b>Enter</b> button is used to confirm a selection in the Menu mode; or used to select check box fields and the <b>ON/OFF</b> switch. In playback mode, it can be used to play or pause the video. In single-frame play mode, pressing the <b>Enter</b> button advances the video by a single frame. And in auto sequence live view mode, the buttons can be used to pause / resume auto sequence.</p>

## Using the IR Remote Control

Your HRG DVR may also be controlled with the IR remote control. Batteries (2 × AAA) must be installed before operation.

Figure 1-4 IR Remote Control

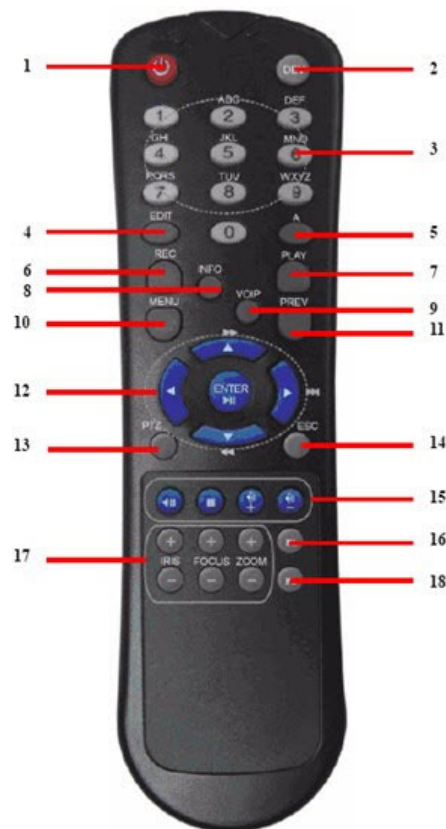

Table 1-2 IR Remote Control

#	Button	Function
1	POWER	Turn On/Off the HRG DVR.
2	DEV	Enable/Disable Remote Control
3	Alphanumerics	Same as front panel
4	EDIT	Same as JKL/EDIT on front panel.
5	A	Same as 0/A on front panel.
6	REC	Same as 7/PQRS/REC on front panel.
7	PLAY	Same as 6/MNO/PLAY on front panel.
8	INFO	Reserved.
9	VOIP	Same as 2/ABC/F1 on front panel.
10	MENU	Same as 1/MENU on front panel.
11	PREV	Same as 9/WXYZ/PREV on front panel.
12	DIRECTION/ENTER	Same as on front panel.
13	PTZ	Same as 8/TUV/PTZ on front panel.
14	ESC	Same as ESC on front panel.
15	RESERVED	Reserved.
16	F1	Same as 2/ABC on front panel.
17	PTZ CONTROL Buttons	Use to adjust the iris, focus, and zoom.
18	F2	The F2 button is used to cycle through tab pages. It can also be used to enter the Channel and OSD Position settings.

See [4-Channel HRG Front Panel on page 27](#) and [8-Channel/16-Channel HRG Front Panel on page 28](#) for more about front panel controls.

## Configuring the IR Remote Control

Aim the remote control at the IR receiver located at the front of the unit to test operation. If there is no response, try the following steps:

1. Use the front control panel or the mouse to navigate to **Menu > Settings > General > More Settings**.
2. Check and remember the HRG DVR ID number. The default ID number is **255**. This ID number is valid for all IR remote controls.
3. Press **DEV** on the remote.
4. Enter the **DVR ID number** from step 2.
5. Press **ENTER** on the IR remote control.

The Status indicator on the front panel should turn green to indicate that the remote control is operating properly.

## Using a USB Mouse

A regular 3-button (Left/Right/Scroll-wheel) USB mouse can also be used with this HRG DVR.

### Connecting a USB Mouse

- Plug the USB mouse into one of the USB ports on the front panel of the HRG DVR.

The mouse should automatically be detected. If, in a rare case, that the mouse is not detected, please refer to the recommended device list from your provider.

### USB Mouse Controls

**Table 1-3 Mouse Controls**

Control	Action	Result
<b>Left button</b>	Single click	Select a menu component, such as a button or an input field. This is similar to pressing the <b>ENTER</b> button on the remote/front panel controls.
	Double click	Switch between single screen and multi-screen mode in Live View/ Playback mode.
	Click and drag	Click and drag the Left mouse button to control the pan/tilt of a PTZ camera as well as to vary the position of the digital zoom area and the camera OSD. It can also be used to setup the alarm areas.
<b>Right button</b>	Single click	Shows pop-up menu.
<b>Scroll wheel</b>	Scroll up	In Live View mode, scrolling up will switch to the previous screen. In Menu mode, it will move the selection to the previous item.
	Scroll down	In Live View mode, scrolling down will switch to the next screen. In Menu mode, it will move the selection to the next item.









## Using the Virtual Keyboard

When a mouse is used to perform a task on the HRG DVR, clicking on a text input field brings up the Virtual Keyboard.

**Figure 1-5 Virtual Keyboard**



**Table 1-4 Virtual Keyboard Controls**

Virtual key	Name	Function
	Lowercase	Indicates that lowercase input is being used.
	Uppercase	Indicates that uppercase input is being used.
	Switch to lowercase	Switch to lowercase input.
	Switch to uppercase	Switch to uppercase input.
	Number	Indicates that number input is being used.
	Symbols	Switch to symbols input.
	Backspace	Delete a character in front of the cursor.
	Enter	Confirm selection.
	ESC	Exit out of the virtual keyboard.

## Rear Panel

Use these diagrams to make the rear panel connections.

### 4-Channel HRG Rear Panel Connections and Switches

**Figure 1-6 4-Channel HRG Rear Panel Connections and Switches**

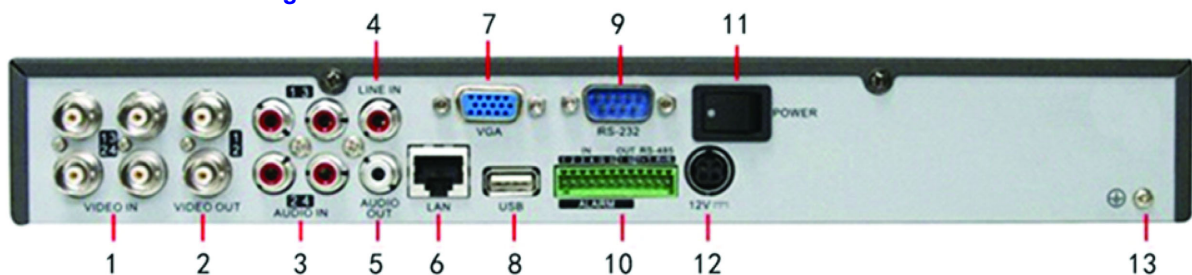
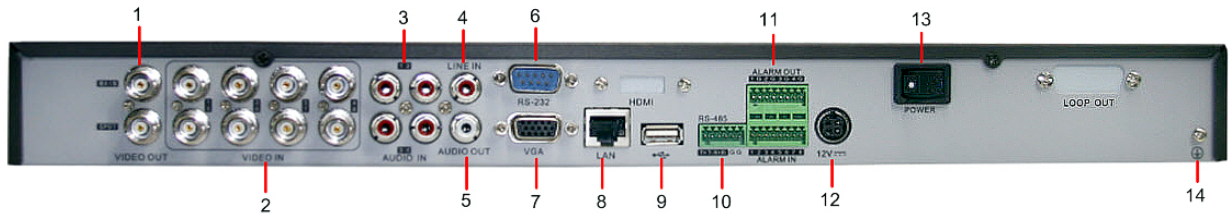

**Table 1-5 4-Channel HRG Rear Panel Connections and Switches**

<b>Position</b>	<b>Connection/Switch</b>	<b>Function</b>
1	<b>Video In</b>	BNC connectors for analog video input.
2	<b>Video Out</b>	BNC connectors for video output.
3	<b>Audio In</b>	RCA connectors for analog audio input.
4	<b>Line In</b>	RCA connector for audio input.
5	<b>Audio Out</b>	RCA connector for audio output.
6	<b>LAN</b>	Connector for LAN (Local Area Network).
7	<b>VGA</b>	DB15 connector for VGA output. Display local video output and menu.
8	<b>USB</b>	Connector for USB devices.
9	<b>RS-232 Port</b>	DB9 connector for RS-232 devices.
10	<b>Alarm In</b>	Connector for alarm input.
	<b>Alarm Out</b>	Connector for alarm output.
	<b>RS-485 Port</b>	Connector for RS-485 devices. T+, T- pins connect to PTZ.
11	<b>Power</b>	Switch for turning <b>On/Off</b> the device.
12	<b>12 V</b>	12 V DC power supply.
13	<b>GND</b>	Ground (needs to be connected when HRG DVR starts up).



## 8-Channel HRG Rear Panel Connections and Switches



## 16-Channel HRG Rear Panel Connections and Switches

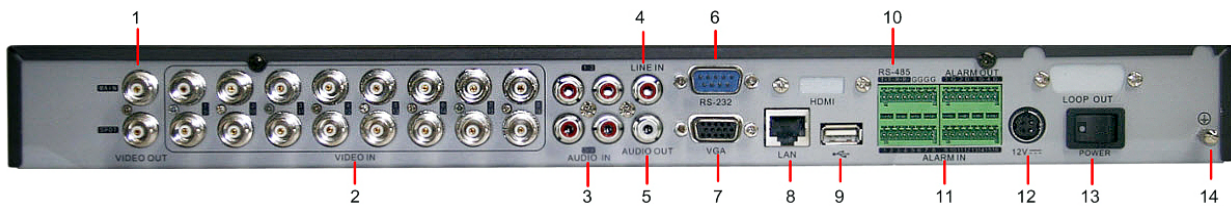

**Table 1-6 8-Channel/16-Channel Rear Panel Connections and Switches**

Position	Connection/Switch	Function
1	Main Video Out	BNC connectors for analog video input.
	Spot Video Out	BNC connectors for spot video out
2	Video In	BNC connectors for analog video input.
3	Audio In	RCA connectors for analog audio input.
4	Line In	RCA connector for audio input.
5	Audio Out	RCA connector for audio output.
6	RS-232 Port	DB9 connector for RS-232 devices.
7	VGA	DB15 connector for VGA output. Display local video output and menu.
8	LAN	Connector for LAN (Local Area Network).
9	USB	Connector for USB devices.
10	RS-485 Port	Connector for RS-485 devices. T+, T- pins connect to PTZ.
11	Alarm In	Connector for alarm input.
	Alarm Out	Connector for alarm output.
12	12 V	12 V DC power supply.
13	Power	Switch for turning <b>On/Off</b> the device.
14	GND	Ground (needs to be connected when HRG DVR starts up).



# 2

## Getting Started

This chapter covers:

- Starting and shutting down the HRG DVR
- Rebooting and locking the HRG DVR
- Using the Setup Wizard
- Setting the date and time

---

### Starting and Shutting Down the HRG DVR

---

Proper startup and shutdown procedures are crucial to maintaining the life of your HRG DVR.

#### Starting the HRG DVR

---

**Note** Ensure that the input voltage meets the requirements of the HRG DVR, and that the GND is grounded.

---

---

**Note** Ensure that the VGA on the HRG DVR rear panel is connected to a display device, or that the VIDEO OUT port is connected to a monitor. You cannot view and navigate the menu without being connected to a monitor.

---

1. Ensure the power supply is plugged into an electrical outlet. It is **HIGHLY** recommended that you use an Uninterruptible Power Supply (UPS) in conjunction with the unit.
2. Press the **POWER** switch on the rear panel. After the power has been started up, the POWER indicator on the HRG DVR will light green.

## Shutting Down the HRG DVR

1. Click **Menu** ► **ShutDown** to enter the **Shutdown** menu (see [Figure 2-1](#)).

**Figure 2-1** Shutdown Menu



2. Click **ShutDown**.
3. Click **Yes** in the pop-up window to confirm that you want to shut down the HRG DVR.

---

## Rebooting and Locking the HRG DVR

---

While in the Shutdown menu, you can also reboot or lock your HRG DVR. Locking your HRG DVR will return you to the Live View mode, which requires a user name and password to exit out of it. The Reboot button reboots your HRG DVR.

1. Click **Menu** ► **ShutDown** to enter the Shutdown menu (see [Figure 2-1](#)).
2. Click **Lock** or **Reboot**.

---

## Using the Setup Wizard

---

By default, the Setup Wizard prompt appears when you turn on the HRG DVR (see [Figure 2-2](#)). The Setup Wizard guides you to configure some of the important settings for your HRG DVR.

---

**Note** If the check box is cleared , then the Setup Wizard will not run again until the factory default settings are resumed.  
If the check box is selected , then the Setup Wizard will start the next time the HRG DVR is turned on.

---

**Figure 2-2 Setup Wizard**

1. Click **Next** to open the **User Permission** window (see [Figure 2-3](#)).

**Figure 2-3 User Permission Window**

2. Navigate to the **Admin Password** input field. Enter the admin password into the **Admin Password** input field. By default, the password is **12345**.
3. Select the **New Admin Password** check box to change the admin password. Enter the new password and confirm.
4. Click **Next** to continue to the **HDD Management** window.

**Figure 2-4 Entering the HDD Management Window**

5. At the prompt, click **Enter** to open the HDD Management window (see [Figure 2-5](#)).
6. If a new hard drive was recently installed, select the HDD from the list, and then click **Init** to initialize it.

Initializing the HDD will format it and remove all data from it.

**Figure 2-5 HDD Management Window**

7. After the HDD has been initialized, click **OK** to return to the **Setup Wizard**.
8. Click **Next** to continue to the **Record Settings** window.

**Figure 2-6** Entering the Record Settings Window



9. At the prompt, click **Enter** to open the Record Settings window (see [Figure 2-7](#)).
10. Select the **Schedule** tab.

**Figure 2-7** Schedule Tab

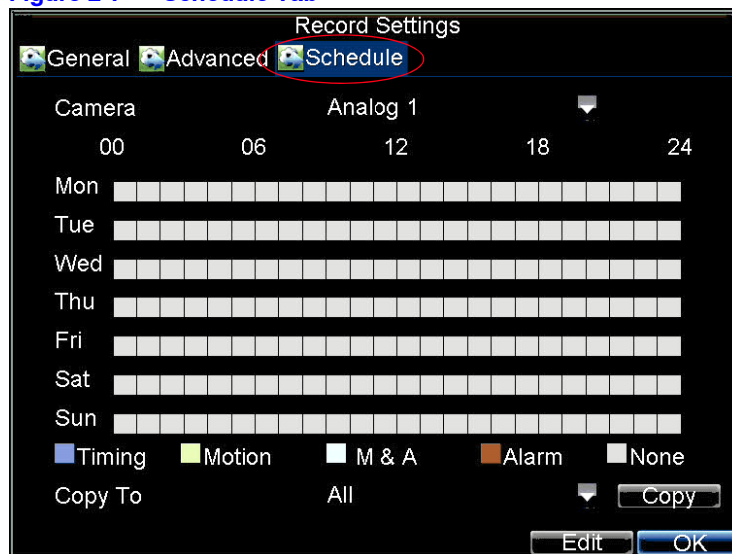

11. Click **Edit**.  
A new recording schedule opens (see [Figure 2-8](#)).

**Figure 2-8 Entering a New Recording Schedule**



12. Select both the **Enable Schedule** and **All Day** check boxes to enable the recording schedule and allow it to record continuously all day.
13. Click **OK** to return to the **Schedule** tab.

---

**Note** To copy the schedule to a different channel, select the channel or all under **Copy To**, and then click **Copy** (see [Figure 2-9](#)).

---

**Figure 2-9 Copying a Schedule**

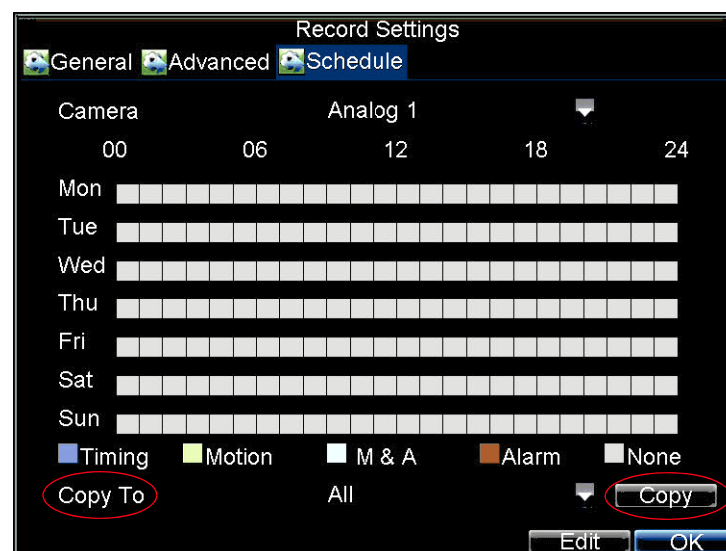

14. Click **Next** to continue to the Network Settings window.

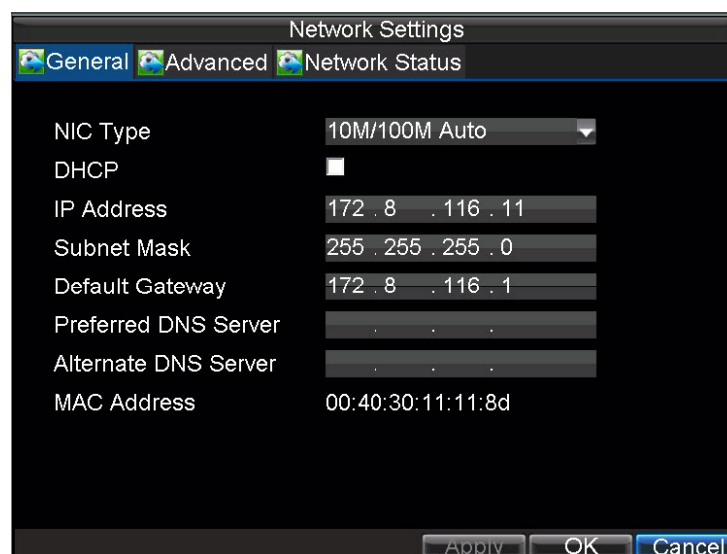

**Figure 2-10 Entering the Network Settings Window**



15. At the prompt, click **Enter** to open the Network Settings window (see [Figure 2-11](#)).

**Figure 2-11 Network Settings Window**



16. Enter the **IP Address**, **Subnet Mask**, and **Default Gateway**.
17. Click **OK** to return to the Setup Wizard.
18. When you are finished entering settings, click **Done** to close the Setup Wizard.
- This completes the initial setup process. Continue to [Setting the Date and Time](#).

---

## Setting the Date and Time

---

You must set up the system date and time to accurately timestamp recordings and events.

To set up the date and time:

1. Open the **General Settings Menu** by doing one of the following:
  - Press **MENU** on the remote control or the front panel of the HRG DVR.
  - Right-click with the mouse, and then click **Menu**.
2. Click **Settings**, and then click **General** to enter the General Settings menu.

**Figure 2-12** Setting the Date and Time

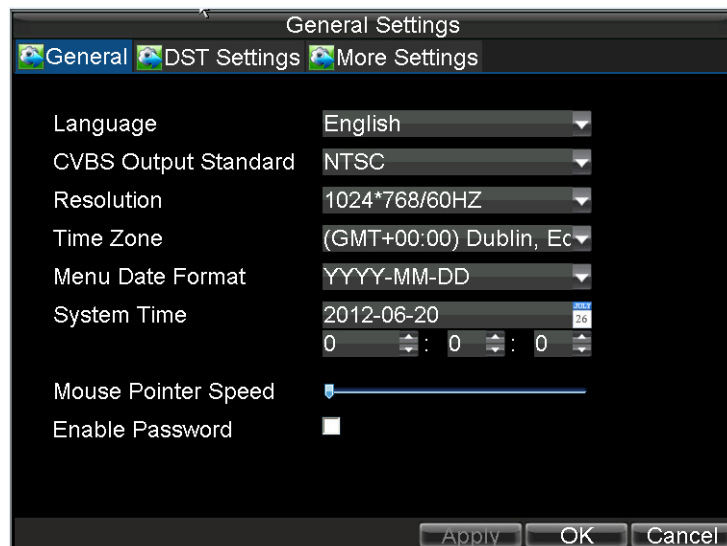

3. Enter the correct date and time in the **System Time** field.
4. Click **Apply** to save the settings.

# 3

## Live View

This chapter describes the Live View on-screen display and how to operate and configure the Live View display.

---

### On-screen Display in Live View

---

Live View mode starts automatically when the HRG DVR is turned on. You can return to Live View mode from any submenu by pressing **ESC** multiple times.

### Live View Icons

Some icons are provided on screen in Live View mode to indicate different camera status. These icons include:



**Main Output**



**Aux Output**



**Event Alarm:** Indicates video loss, video tampering, motion detection, or relay alarm.



**Record:** Indicates the current channel that is recording. The recording can be started manually or from a schedule, and/or when a motion detection or alarm event is triggered.



**Event Alarm & Record**

---

## Operating Live View

---

In Live View mode, you can select the following options:

- |                               |  |
|-------------------------------|--|
| <b>Display Single Camera</b>  | <ul style="list-style-type: none"> <li>• <b>Front Panel/Remote:</b> Use the alphanumeric buttons.</li> <li>• <b>Mouse:</b> Right-click anywhere in the window, and then click <b>Single Camera</b>.</li> </ul>   |
| <b>Multi-camera Live View</b> | <ul style="list-style-type: none"> <li>• <b>Front Panel/Remote:</b> Press the <b>PREV</b> button.</li> <li>• <b>Mouse:</b> Right-click anywhere in the window, and then click <b>Multi Camera</b>.</li> </ul>  |
| <b>Manual Switch</b>          | <ul style="list-style-type: none"> <li>• <b>Front Panel/ Remote:</b> Press the left arrow button to access the previous screen. Press the right arrow button to access next screen.</li> <li>• <b>Mouse:</b> Right-click anywhere in the window, and then click <b>Next Screen</b>.</li> </ul> |
| <b>Auto Sequence</b>          | <ul style="list-style-type: none"> <li>• <b>Front Panel/Remote:</b> Press the <b>↵</b> (Enter) button.</li> <li>• <b>Mouse:</b> Right-click anywhere in the window, and then click <b>Start Auto-switch</b>.</li> </ul>  |
| <b>Digital Zoom</b>           | <ul style="list-style-type: none"> <li>• <b>Mouse:</b> Right-click anywhere in the window, and then click <b>Digital Zoom</b>.</li> </ul>  |

## Using the Mouse in Live View

Some functions of the Live View can be quickly accessed by clicking the right mouse button (see [Figure 3-1](#)).

**Figure 3-1 Live View Shortcut Menu**



Menu items include:

- **Single Camera:** Switch to a full-screen display of the selected camera by drop-down submenu.
- **Multi Camera:** Switch between different multi-camera display modes by drop-down submenu.
- **Next Screen:** When displaying less than the maximum number of cameras in Live View, select this option to switch to the next camera display.
- **Playback:** Enter Playback mode of the selected camera.
- **PTZ:** Enter PTZ control mode of the selected camera.
- **Digital Zoom:** Enter Digital Zoom interface of the selected camera.
- **Menu:** Enter Main menu.
- **Start Auto-switch:** Enable multi-camera sequence in Live View mode.

---

**Note** The dwell time of the Live View configuration should be set before using **Start Auto-switch** function.

---

## Using the Digital Zoom

To use digital zoom in Live View mode:

1. Right-click the mouse in Live View mode, and then click **Digital Zoom**.
2. Drag the red box to the desired area for zooming.

The zoomed image will be magnified by 4 times (see [Figure 3-2](#)).

**Figure 3-2** Digital Zoom

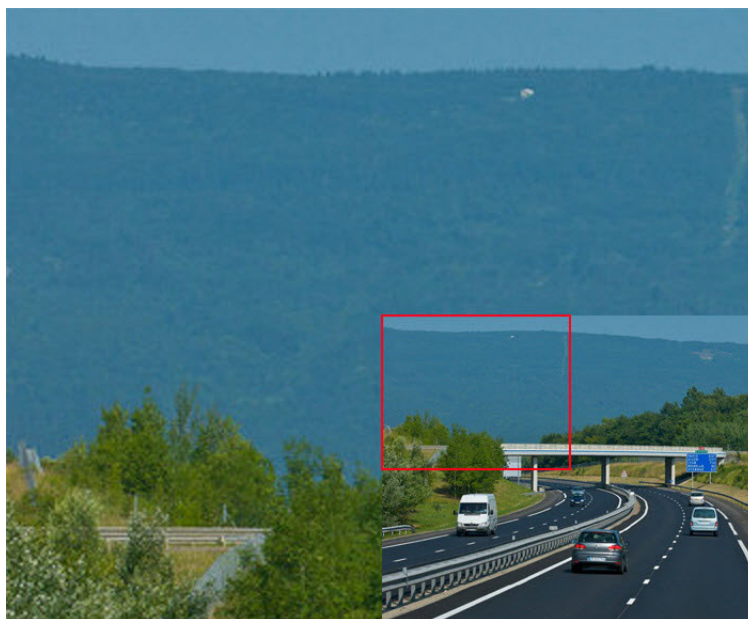

---

## Configuring the Live View Display

---

Click **Menu** > **Settings** > **Display** to enter the Display Settings Menu (see [Figure 3-3](#)).

**Figure 3-3** Display Settings Menu



Configure the following settings:

- **Video Output:** Set the video output modes, including **VGA**, **Aux Output**, and **Main CVBS**.
- **Mode:** Set the live view display mode to be **1×1**, **2×2**, **3×3**, or **4×4**.
- **Dwell Time:** Set the dwell time for camera switching when **Start Auto-switch** is selected in Live View.
- **Camera Order:** Set the camera order for display in the selected mode (see [Setting the Camera Order](#)).
- **Enable Audio Output:** Enable/disable audio output for the selected video output.
- **Event Output Port:** Set the port for event output to be **VGA**, **Main CVBS**, or **Aux Output**.
- **Event Dwell Time:** Set the dwell time for event video display.

## Setting the Camera Order

The Camera Order settings allow you to set camera sequence in selectable Live View display mode (see [Figure 3-4](#)).

**Figure 3-4 Camera Order Settings**



To set the camera order, do the following:

1. Click **Menu > Settings > Display** to enter the Display Settings menu.
2. Next to **Camera Order**, click **Set**.
3. Select the video output port and the display mode (**1×1**, **2×2**, **3×3**, and **4×4** selectable).
4. Use the direction buttons on the front panel of the DVR to move to the display pane for setting, and then press **←** to confirm the selection.
5. Use the direction buttons on the front panel of the DVR to select the camera you want to be view in the display pane.  
The option 'x' indicates that no camera is displayed.
6. Press **←** to confirm the selection.





# 4

## Recording Settings

This chapter explains how to configure recording settings for the HRG DVR, including setting scheduled recording.

---

### Configuring Recording Settings

---

There are multiple ways to set up your HRG DVR for recording. These include setting up a recording schedule, triggering a recording by motion detection and/or a sensor alarm, and starting a recording manually.

### Initializing Recording Settings

1. Click **Menu** > **Settings** > **Record** to enter the Record Settings menu (see [Figure 4-1](#)).

**Figure 4-1** General Record Settings Menu



2. Select the camera you want to configure.

3. Configure the following settings:
  - **Encoding Parameters:** Set the encoding parameters to be **Normal** or **Event**.
  - **Stream Type:** Set the stream type to be **Video** or **Video & Audio**.
  - **Resolution:** Set recording resolution at **4CIF**, **2CIF**, **CIF**, or **QCIF**.
  - **Bit Rate Type:** Set the bit rate type to be **Variable** or **Constant**.
  - **Video Quality:** Set the recording video quality (6 levels configurable).
  - **Frame Rate:** Set the frame rate of recording.
  - **Max Bit Rate:** Select or customize the maximum bit rate for recording.
4. Next to **More Settings**, click **Set** to configure more recording settings (see [Figure 4-2](#)).

**Figure 4-2 More Record Settings**



- **Pre-Record:** Set the time in seconds to pre-record before the actual recording begins.
  - **Post-Record:** Set the time in seconds to post-record after the actual recording has ended.
  - **Recording Expired Time:** Set the expiration time in days for recorded video. Recorded files after expiration time will be deleted. The actual period for record files storage is determined by the available HDD space.
  - **Record Audio:** Enable or disable audio recording of the selected camera.
5. Press the **3DEF/F2** button on the front panel of the HRG DVR to select the **Advanced** tab. The Advanced Record Settings menu is displayed (see [Figure 4-3](#)).

**Figure 4-3 Advanced Record Settings**

6. Next to **Overwrite**, select **Yes** or **No** to enable or disable the overwrite setting.  
Enabling the overwrite setting causes recorded files to be overwritten once the HDD is full.
7. Click **Apply**, and then click **OK** to exit the menu.

## Scheduling Recording

The Schedule Record Settings menu allows you to set up flexible recording schedules for daily or weekly recording.

To set up a recording schedule:

1. Click **Menu** > **Settings** > **Record** to enter the Record Settings menu.
2. Select the **Schedule** tab to enter the Schedule Record Settings menu (see [Figure 4-4](#)).

**Figure 4-4 Schedule Record Settings Menu**

3. Select the camera for which you want to configure a recording schedule.
4. Click **Edit** to enter the Schedule Settings menu.

5. Select the **Enable Schedule** check box.
6. Select the day you want to record or select **All Week** to record the entire week.
7. Click **All Day** to enable recording for the entire day, or select different periods for each day. Up to eight time periods can be scheduled.

---

**Note** Scheduled time periods cannot be overlapped.

---

8. Select the recording type.  
The recording type can be selected to scheduled or triggered by motion detection and/or alarm. For more specific settings about motion detection and alarm recordings, please refer to [Configuring Alarms on page 59](#).
9. Click **OK**.
10. Repeat [step 3](#) to [step 9](#) for other cameras, or copy settings from one schedule to the others under **Copy To**.
11. Click **OK** to save the settings.

---

**Note** The Event encoding parameters will take effect when motion detection or alarms are triggered. The Timing encoding parameters will take effect when there no events are occurring.

---

## Starting a Manual Recording

A manual recording can be enabled at any time by means of the following configuration:

1. Click **Menu** > **Manual Record** to enter the Manual Record menu (see [Figure 4-5](#)).

**Figure 4-5** Manual Record Menu

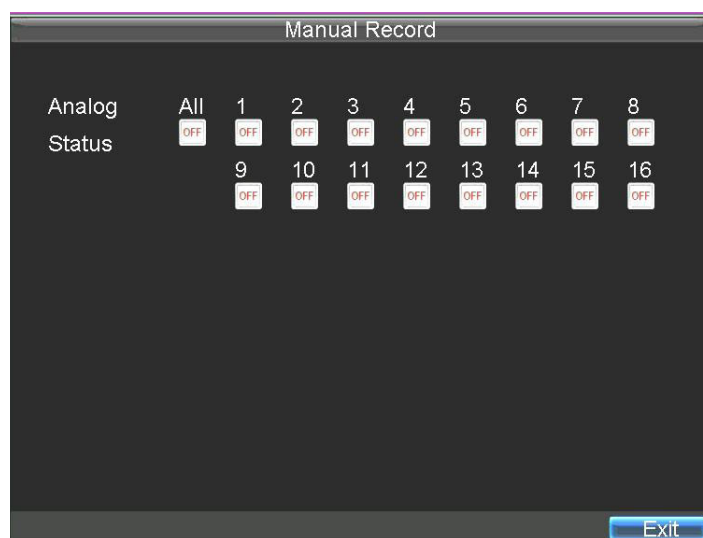

2. Start manual recording by selecting **ON** or **OFF** for each camera.

---

## Protecting Recorded Files

---

Two methods are provided to prevent recorded files from being deleted from the HDD or from being overwritten during cycle recording. You can set the recorded files to be locked or you can set the HDD that the files reside on to be read-only.

## Locking and Unlocking Recorded Files

To lock or unlock a recorded file:

1. Click **Menu** > **Video Search** to enter the Video Search menu (see [Figure 4-6](#)).

**Figure 4-6** Video Search Menu



2. Search for the desired recording by entering search parameters. Search parameters include Camera ID, Video/File Type, and Start/End Time.
3. Click **Search**.  
A list of recorded files (see [Figure 4-7](#)) matching the search parameters are displayed.

**Figure 4-7 Video Search Result List**

CH.	Start Time	Stop Time	File Type
A1	06-24-2010 13:36:18	13:44:19	🔒
A1	06-29-2010 16:33:38	16:35:47	🔒
A1	06-29-2010 16:37:09	16:39:10	🔒
A1	06-29-2010 16:51:17	16:51:37	🔒
A1	06-29-2010 17:52:11	17:52:26	🔒
A1	06-29-2010 17:52:29	17:52:41	🔒
A1	06-29-2010 17:52:56	17:53:08	🔒
A1	06-29-2010 17:53:51	17:54:04	🔒
A1	06-29-2010 17:54:23	17:54:38	🔒
A1	06-29-2010 17:55:11	17:55:24	🔒
A1	06-29-2010 17:57:15	17:57:30	🔒
A1	06-29-2010 17:57:41	17:58:16	🔒
A1	06-29-2010 17:58:51	17:59:05	🔒

4. Select the file you want to lock/unlock.
5. Click **Lock** to lock the file. If the file is already locked, click **Unlock** to unlock file.  
Locked files are shown with a closed lock, while unlocked files are shown with an opened lock.
6. Click **Cancel** to exit the menu.

## Setting the Hard Drive to Read-Only

To set a HDD to read-only:

1. Click **Menu** ► **HDD** to enter the HDD Management menu (see [Figure 4-8](#)).

**Figure 4-8 HDD Management Menu**

Label	Capacity	Free Space	Status	Group	Pro
1	465.76GB	392.75GB	Normal	1	R/W

2. Select the **General** tab.
3. Select the HDD to set to read-only.
4. Click **Property** to enter the Property Settings menu (see [Figure 4-9](#)).

**Figure 4-9 HDD Property Settings Menu**

5. Set the **HDD Status** to **Read-only**, and then click **OK** to save the settings.

---

**Note** Once set to read-only, the HDD cannot be written to until it is set back to read/write (**R/W**).

---

---

**Note** For models installed with one HDD only, when the property is set to read-only, the recording of the device will be stopped.

---





# 5

## Playback

This chapter describes the playback controls and the various methods of playing back recorded video, including playback from a search and playing back frame-by-frame.

---

### Video Playback

---

The Client application allows all users to play back record files of the specified period. Multi-camera simultaneous playback is supported.

### Playback Interface

Multiple toolbar and buttons are provided on the Playback interface to control the video playback (see [Figure 5-1](#)).

**Figure 5-1 Playback Interface**



The Playback Control panel (see [Figure 5-2](#)), provides various control buttons for video playback.

Figure 5-2 Playback Control Panel

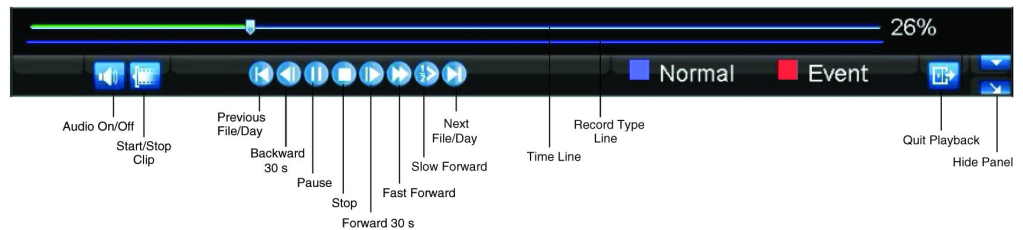

**Note** A blue bar ■ refers to the *Normal* recording (scheduled, manual), while the red bar ■ indicates *Event* recording.

## Playback by Search

To play back record files by video search:

1. Click **Menu** ► **Video Search** to enter the Video Search menu.
2. Set the search parameters by selecting which cameras to search, the video type, the file type, and the start and end times (see [Figure 5-3](#)).

Figure 5-3 Video Search Menu



3. Click **Play** to start playback of all files found, or click **Search** to see a list of search results.
4. Select the file you want to play back, and then press **Play**.

Recorded files will automatically be played back in the Playback interface (see [Figure 5-4](#)).

Figure 5-4 Playback Interface



## Playback in Live View Mode

The Client application also allows you to play back recorded files in Live View mode.

To play back by channel in Live View mode:

1. Right-click on the desired channel, and then click **Playback**.



Recorded video from the selected channel will start playing back in the Playback window. An **Attention** message will appear if there are no recordings found in the previous five minutes.

2. Optionally, you can select additional channels for play back from the channel list on the right side of the Playback interface (see [Figure 5-5](#)).

Figure 5-5 Playback Interface



### Multi-camera Playback

1. Select the cameras from the list for which you want simultaneous playback.
2. Click  to stop the ongoing video playback.
3. Click  to start multi-camera simultaneous playback.

#### Note

- Up to 16 cameras can be played back simultaneously.
- The camera list operation is accessible by mouse only. Please do not operate by front panel.
- If the camera numbered the lowest among the multiple cameras selected for simultaneous playback provides no recorded files for the current day selected on the calendar, then the warning message Playback failed will be displayed on the screen.
- The video for simultaneous playback by multiple cameras selected from the camera list refers to the all-day recorded files of the selected day.

## Playback by System Log

To play back video from the System Log:

1. Click **Menu** > **Maintenance** > **Log Search** to enter the Log Search menu (see *Figure 5-6*).

**Figure 5-6** Log Search Menu

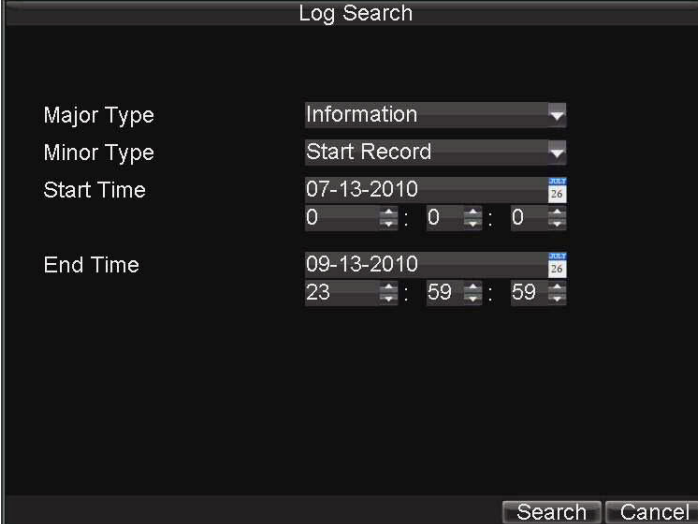

2. Set **Major Type** to **Information**, set **Minor Type** to **Start Record** or **End Record**, and then select the **Start Time** and **End Time**.
3. Click **Search**.  
A list of search results is displayed.
4. Select the video log to play back, and then click **Play**.  
The selected recording will begin to play in the Playback interface.

## Playback Frame-by-Frame

To play back frame-by-frame in the Playback interface:

### Using a Mouse

1. Click **Slow Forward** on the Playback Control Panel until the speed changes to single frame.
2. Click **Pause** to advance the video frame by frame.

### Using the Front Panel/Remote Control

1. Press the down arrow to change the playback speed to single frame.
2. Press **↵** (Enter) to advance the video frame by frame.

## Digital Zoom

To use digital zoom in Playback mode:

1. Right-click the mouse in Playback mode.
2. Click **Digital Zoom** in the drop-down submenu.
3. Drag the red box to the desired area for zooming.

The zoomed image will be magnified by 4 times (see [Figure 5-7](#)).

**Figure 5-7 Digital Zoom in Playback Mode**





# 6

## Backup

This chapter describes how to back up recorded files, including exporting files and video clips.

---

### Backing Up Recorded Files

---

Recorded files can be backed up to various devices, such as USB flash drives, USB hard drives, or a DVD writer.

### Exporting Files

To export recorded files:

1. Click **Menu** ► **Video Export** to enter the Record Backup menu (see [Figure 6-1](#)).

**Figure 6-1** Record Backup Menu



2. Select the desired parameters to search for recorded files to export.
3. On the toolbar, click **Export**.

A list of video search results is displayed (see [Figure 6-2](#)).

**Figure 6-2 Video Search Results**



4. Select the recorded files you want to export. You can also click **Play** to confirm the recorded file you want to export.  
The size of the currently selected files is displayed at the lower-left corner of the window.
5. Click **Next** to enter the Export menu (see [Figure 6-3](#)).

**Figure 6-3 Export Menu**



6. Select the device to which the record file is to be exported from drop-down list (USB Flash Drive, USB HDD, DVD Writer).
7. If the backup device is not recognized:
  - Click **Refresh**.
  - Reconnect the device.
  - Check for compatibility from vendor (see [Troubleshooting the HRG DVR on page 113](#)).
8. Click **Start** to begin the backup process (see [Figure 6-4](#)).



Figure 6-4 Backup Progress Screen



9. After the backup process has completed ([Figure 6-5](#)), select a file from your device and click **Play** to verify that it has been exported successfully.

Figure 6-5 Export Successful Screen



---

**Note** Video Player software will automatically be copied to the device that the recorded files were exported to.

---

## Exporting Video Clips

You can select video clips to export directly in Playback status. A maximum of 30 clips can be selected for each channel.

### Exporting Video Clips Using the Mouse

To export video clips during Playback using the mouse:

1. Enter the Playback interface (see [Video Playback on page 47](#)).

- Click **Start/Stop Clip** on the Playback Control Panel (see [Figure 5-2](#)), and select the start and end of the video clip during playback. Repeat for additional clips.
- Click **Quit Playback** to exit the Playback interface. You are then prompted to save the clips (see [Figure 6-6](#)).

**Figure 6-6 Save Video Clips Prompt**



- Click **Yes** to enter the Backup interface, or click **No** to exit the Playback interface.
- In the Backup interface, click **Start** to begin the backup process.

## Exporting Video Clips Using the Front Panel/Remote

To export video clips during Playback using the Front Panel/Remote:

- Enter the Playback interface (See [Video Playback on page 47](#)).
- During playback, press **Edit** to mark the start of the clip.
- Press **Edit** again to mark the end of the clip.
- Repeat steps 2 and 3 for additional clips.
- Press the **ESC** button to exit the Playback interface. You will then be prompted to save the clips (see [Figure 6-6](#)).
- Click **Yes** to enter the Backup interface, or click **No** to exit the Playback interface.
- In the Backup interface, click **Start** to begin the backup process.

## Managing Backup Devices

To manage backup devices, you must first be in the Export menu (see [Figure 6-7](#)). The Export menu can be accessed by following the steps shown in the section [Exporting Files](#).

**Figure 6-7 Export Menu**



From the Export menu, you can select the following options:

- **New Folder:** Create a new folder on the export device.
- **Delete:** Delete a file or folder from the export device.
- **Play:** Play the selected video file on the export device.
- **Format:** Format the export device.
- **Erase:** Erase files from a re-writable CD or DVD.



# 7

## Alarm Settings

This chapter describes how to configure the HRG DVR to detect and respond to alarms.

---

### Configuring Alarms

---

#### Motion Detection Alarm

To configure Motion Detection recording, do the following:

1. Click **Menu** > **Settings** > **Camera** to enter the Camera Settings menu (see [Figure 7-1](#)).

**Figure 7-1** Camera Settings Menu

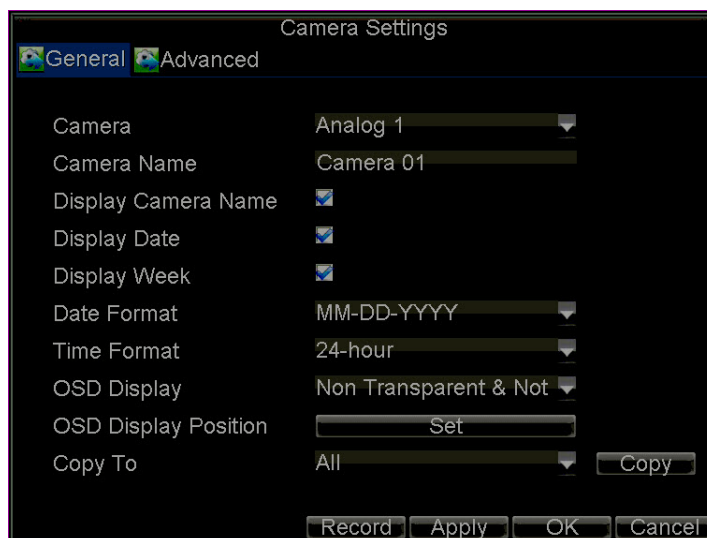

2. Select the **Advanced** tab to enter the Advanced Camera Settings menu (see [Figure 7-2](#)).

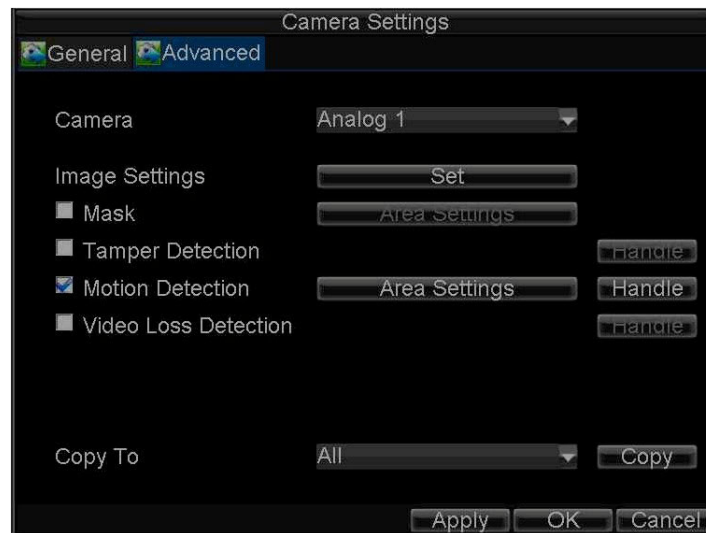
**Figure 7-2 Advanced Camera Settings - Motion Detection**

3. Select the **Motion Detection** check box, and then click **Area Settings** to enter the Motion Detection Area Settings interface.
4. Mask the Motion Detection area by dragging the grid with your mouse (see [Figure 7-3](#)). The maximum area can be set to full screen. You can also use the **EDIT** and direction buttons on the front panel of the HRG DVR to configure the Motion Detection area.

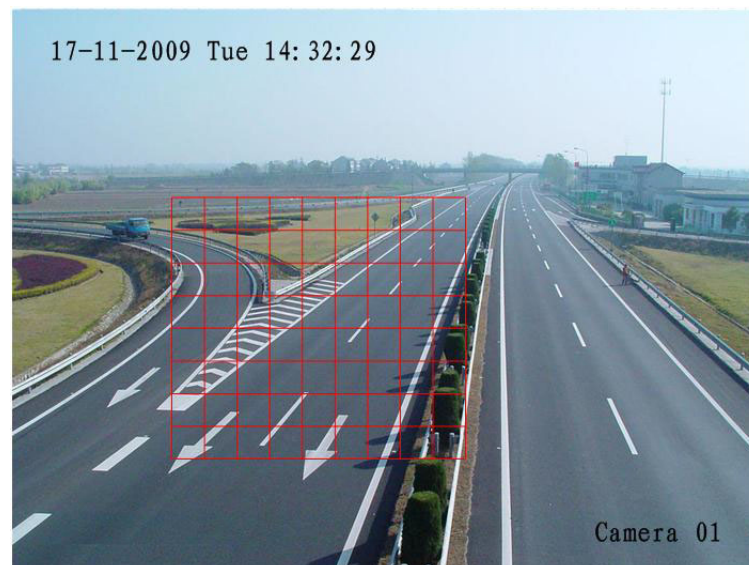
**Figure 7-3 Motion Detection Area Settings Interface**

5. Right-click anywhere in the window or press **MENU** on the front panel of the DVR to set the Motion Detection Sensitivity (see [Figure 7-4](#)). The higher the value, the higher the sensitivity level.

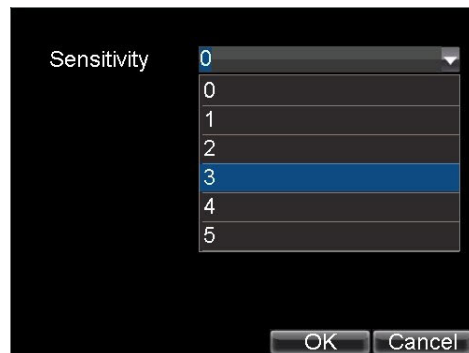
**Figure 7-4 Motion Detection Sensitivity Settings**

6. Click **OK** to return to the Motion Detection Area Settings interface.
7. Right-click anywhere in the window, and then click **Exit** to return to the Advanced Camera Settings menu.
8. Click **Handle** to enter the Exception Handle menu (see [Figure 7-5](#)).

**Figure 7-5 Exception Handle Menu**

9. Select cameras to trigger for recording when motion is detected by selecting the check boxes under the desired cameras.
10. Select the **Schedule** tab to set when you want motion detection to be enabled (see [Figure 7-6](#)). The schedule can be set for all week or any day of the week, with up to eight time periods per day.

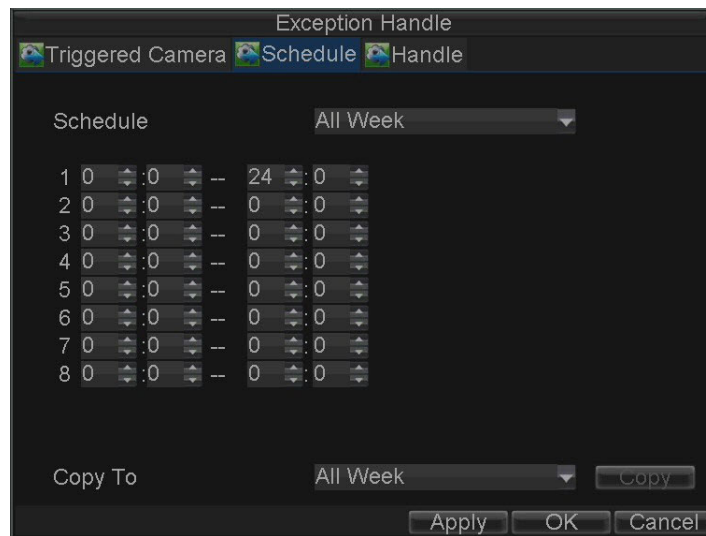
**Figure 7-6** Schedule Settings

**Note** After you have configured the schedule, the HRG DVR must be restarted for the new settings to take effect.

11. Select the **Handle** tab to configure exceptions handling (see [Figure 7-7](#)). Exception trigger options are described in [Understanding Exception Trigger Options on page 81](#).

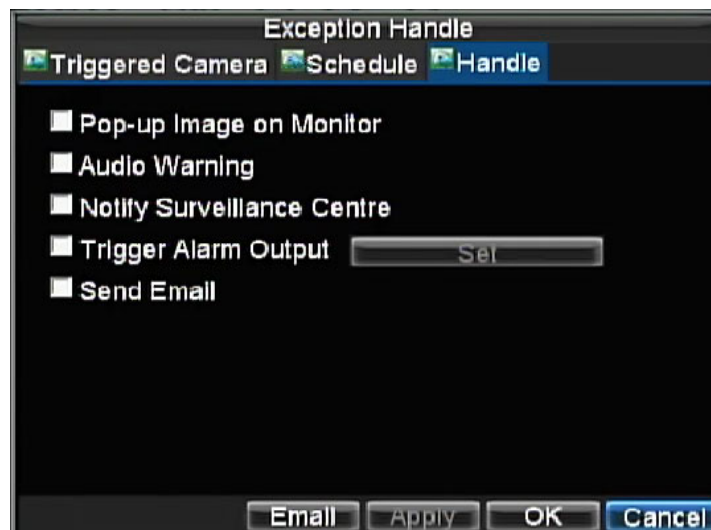
**Figure 7-7** Handle Settings

12. Click **OK** to save the settings for the selected camera.

You can now add a schedule to start recording when motion is detected (see [Scheduling Recording on page 41](#)).

## Sensor Alarm Settings

Recordings can be triggered from an external relay alarm device.

To set up sensor alarms:



1. Click **Menu** > **Settings** > **Alarm** to enter the Alarm Settings menu (see [Figure 7-8](#)).

**Figure 7-8 Alarm Settings Menu**

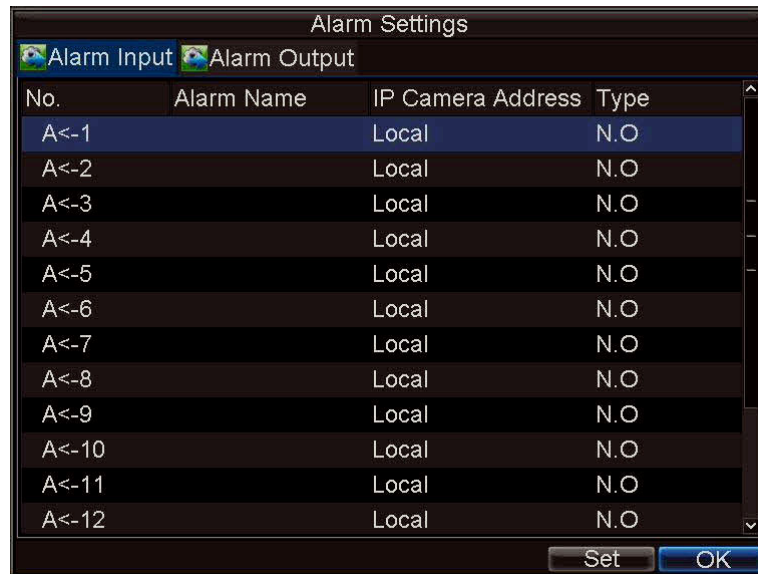

2. Select the **Alarm Input Number**, and then click **Set** to enter the Alarm Input Settings menu (see [Figure 7-9](#)).

**Figure 7-9 Alarm Input Settings Menu**

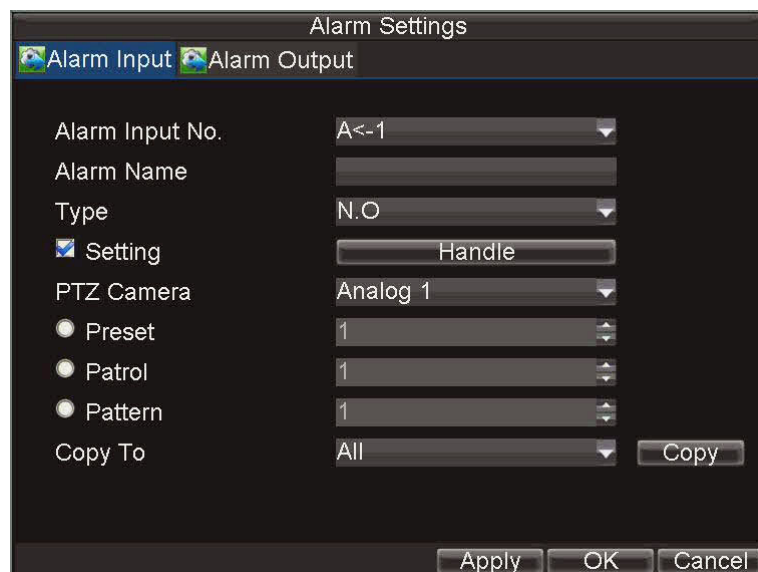

3. Set **Type** to Normally Opened (**N.O**) or Normally Closed (**N.C**).
4. Select the **Setting** check box, and then click **Handle** to enter the Alarm Input Handle menu (see [Figure 7-10](#)).

**Figure 7-10 Alarm Input Handle Menu**

5. Select the **Triggered Camera** tab.
6. Select cameras to trigger for recording when an alarm occurs by selecting the check boxes under the desired cameras (see [Figure 7-10](#)).  
You can select a PTZ camera to link with the alarm input and then set the call up of preset, patrol, and pattern for alarm-linked actions.
7. Click **OK** to save the settings.
8. You can now add a schedule to start recording when an alarm is triggered (see [Scheduling Recording on page 41](#)).

Alarm outputs can also be configured in the Alarm Settings menu.

To set up an Alarm Output:

1. Select the **Alarm Output** tab to enter the Alarm Output interface (see [Figure 7-11](#)).

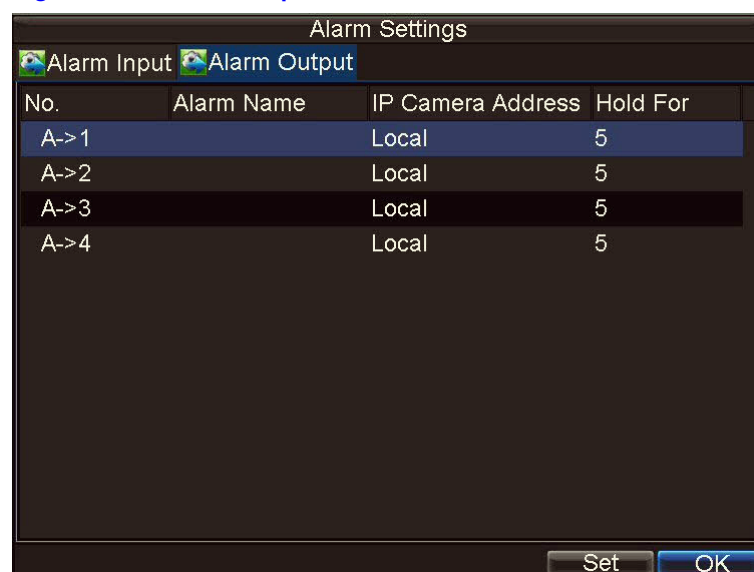
**Figure 7-11 Alarm Output Interface**

2. Select the output you want to configure, and then click **Set** to enter the settings page for the selected channel (see [Figure 7-12](#)).

Figure 7-12 Alarm Output Settings

Alarm Settings

Alarm Input Alarm Output

Alarm Output No. A->1

Alarm Name

Hold For 5s

Schedule All Week

1	0	:	0	--	24	:	0
2	0	:	0	--	0	:	0
3	0	:	0	--	0	:	0
4	0	:	0	--	0	:	0
5	0	:	0	--	0	:	0
6	0	:	0	--	0	:	0
7	0	:	0	--	0	:	0
8	0	:	0	--	0	:	0

Copy To All

Apply OK Cancel

3. Configure the settings for the selected output.
4. Click **OK** to save the settings.

---

**Note** If **Hold For** is set as **Manually Stop**, the alarm will only stop when you manually turn it off (see [Manual Alarm Triggering](#)).

---

## Manual Alarm Triggering

You can trigger alarm outputs manually through the Manual Alarm menu.

To trigger alarm outputs manually:

1. Click **Menu** > **Manual Alarm** to enter the Manual Alarm menu (see [Figure 7-13](#)).

Figure 7-13 Manual Alarm Menu

Manual Alarm

Alarm Output	Alarm Name	IP Camera Address	Trigger
A->1		Local	No
A->2		Local	No
A->3		Local	No
A->4		Local	No

Trigger Trigger All Clear All OK

2. Configure the following settings in the Manual Alarm menu:
  - **Trigger:** Select an alarm from the list and click **Trigger** to trigger its output.
  - **Trigger All:** Trigger all alarm outputs at once.
  - **Clear All:** Stop all alarm outputs at once.
3. Click **OK** to save the settings.

## Video Loss Detection

The DVR can be set up to detect video loss and trigger an action.

To set up video loss detection:

1. Click **Menu** > **Settings** > **Camera** to enter the Camera Settings menu (see [Figure 7-14](#)).

**Figure 7-14** Camera Settings Menu

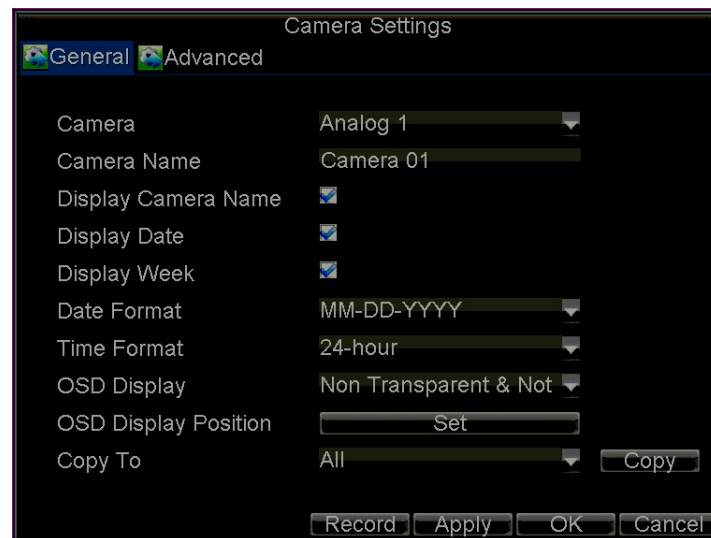

2. Select the **Advanced** tab to enter the Advanced Camera Settings menu.
3. Select the camera to be configured with video loss detection.
4. Select the **Video Loss Detection** check box to enable this feature (see [Figure 7-15](#)).

Figure 7-15 Advanced Camera Settings - Video Loss Detection

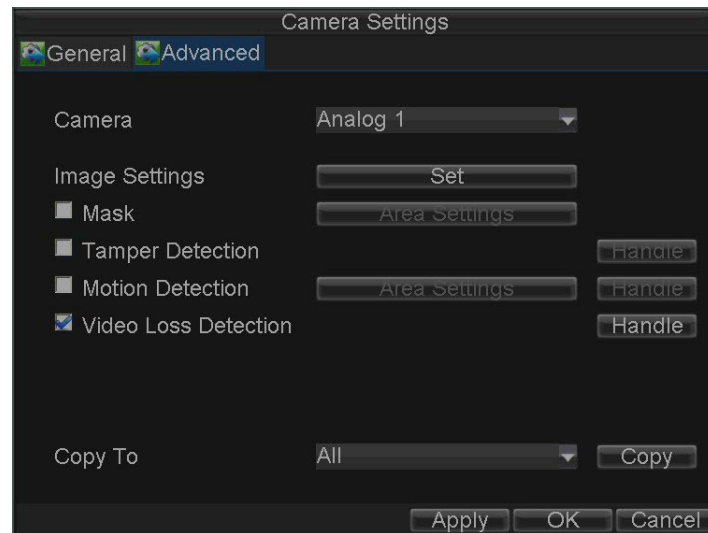

5. Next to **Video Loss Detection**, click **Handle** to enter the Exception Handle menu.
6. Select the **Schedule** tab to set when you want video loss detection to be enabled (see [Figure 7-16](#)). The schedule can be set for all week or any day of the week, with up to eight time periods per day.

Figure 7-16 Schedule Settings

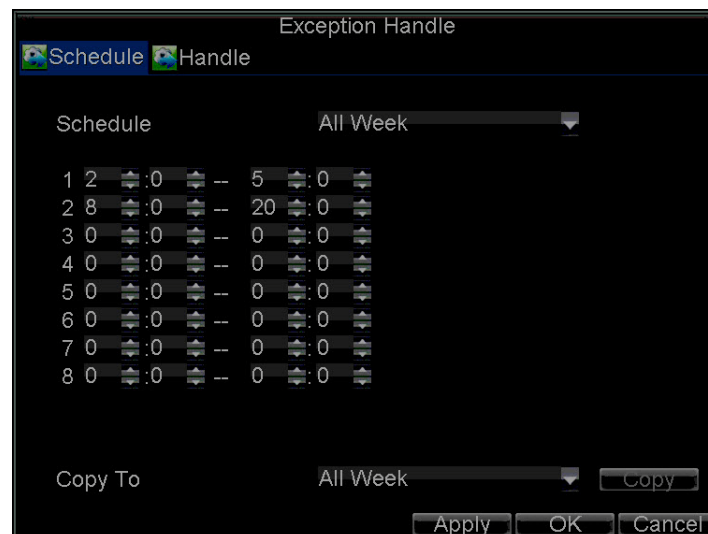



---

**Note** After you have configured the schedule, the HRG DVR must be restarted for the new settings to take effect.

---

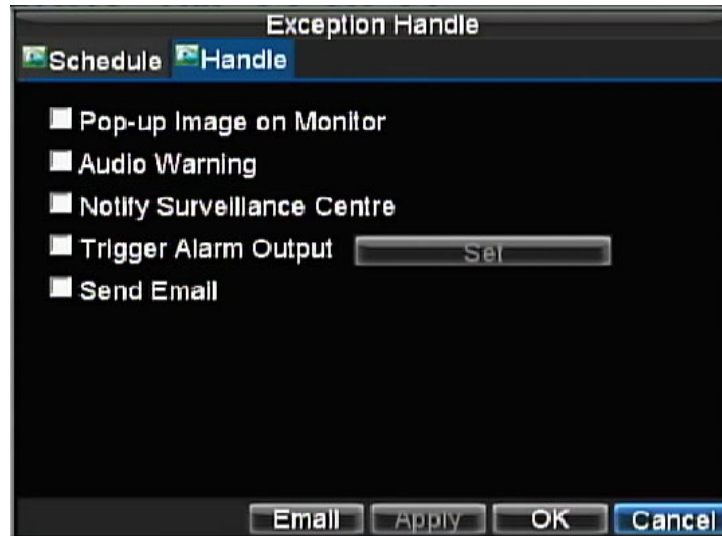
7. Select the **Handle** tab to configure exceptions handling (see [Figure 7-17](#)). Exception trigger options are described in [Understanding Exception Trigger Options on page 81](#).

**Figure 7-17 Handle Settings**

8. Click **OK** to save the settings.
9. Repeat [step 3](#) to [step 8](#) to configure settings for other channels.

## Video Tampering Detection

The video tampering can also be detected and set to trigger an action on your DVR.

---

**Note** The video tampering detection area is in full-screen mode by default and cannot be configured.

---

To set up video tampering detection:

1. Click **Menu** > **Settings** > **Camera** to enter the Camera Settings menu (see [Figure 7-18](#)).

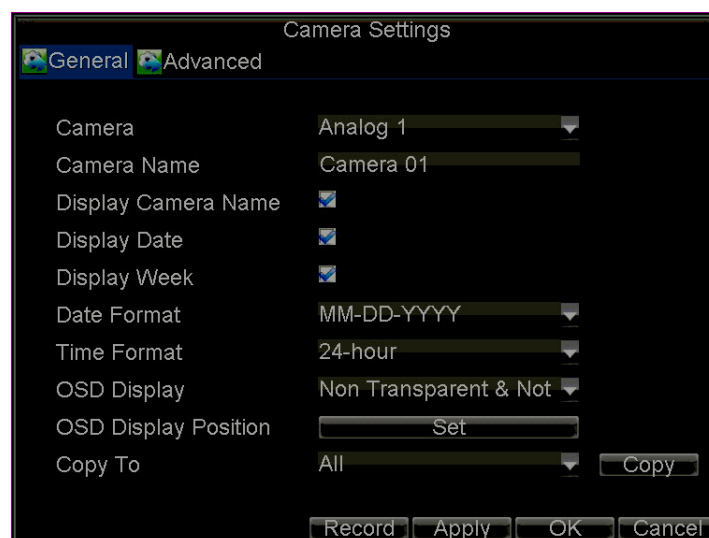
**Figure 7-18 Camera Settings Menu**

2. Select the **Advanced** tab to enter the Advanced Camera Settings menu.
3. Select the camera to be configured with video tampering detection.
4. Select the **Tamper Detection** check box to enable this feature (see [Figure 7-19](#)).

**Figure 7-19 Advanced Camera Settings - Tamper Detection**

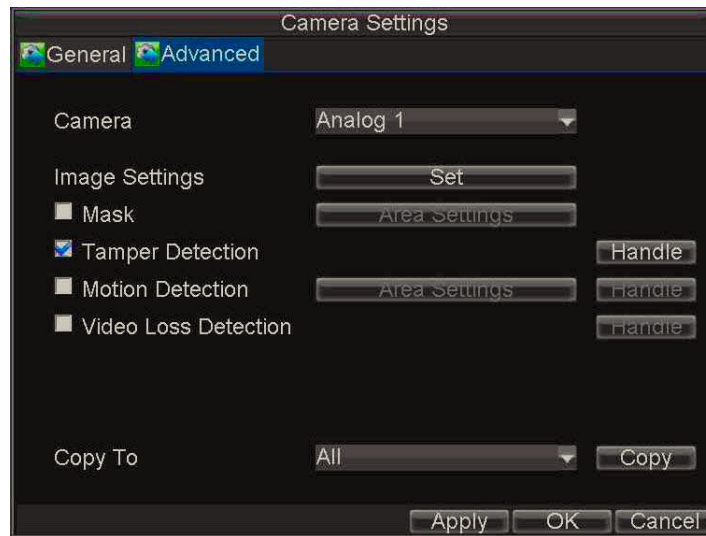

5. Next to **Tamper Detection**, click **Handle** to enter the Exception Handle menu.
6. Select the **Schedule** tab to set when you want video tampering detection to be enabled (see [Figure 7-20](#)). The schedule can be set for all week or any day of the week, with up to eight time periods per day.

**Figure 7-20 Schedule Settings**

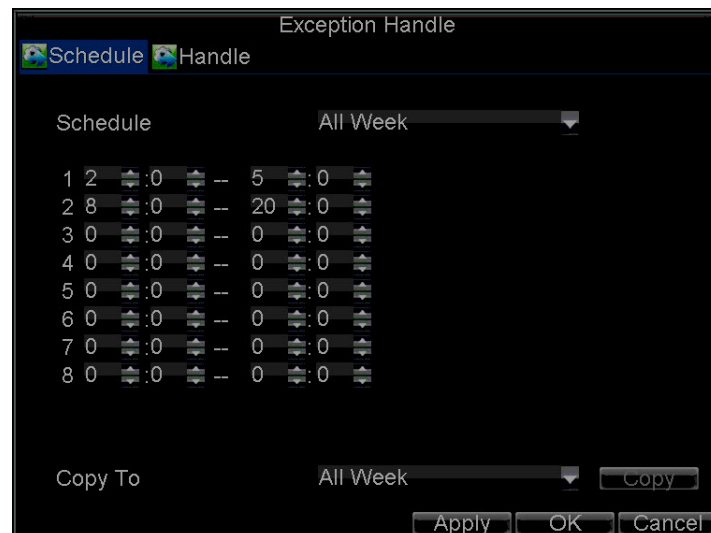



---

**Note** After you have configured the schedule, the HRG DVR must be restarted for the new settings to take effect.

---

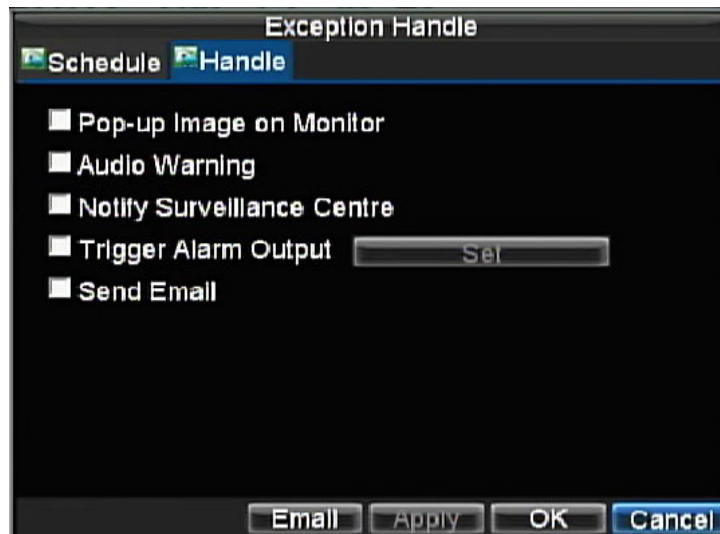
7. Select the **Handle** tab to configure exceptions handling (see [Figure 7-21](#)). Exception trigger options are described in [Understanding Exception Trigger Options on page 81](#).

**Figure 7-21 Handle Settings**

8. Click **OK** to save the settings.
9. Repeat [step 3](#) to [step 8](#) to configure settings for other channels.

---

## Exception Settings

---

The exception setting allows the DVR to alert you when irregular events occur. These events include:

- **HDD Full:** All installed hard drives are full.
- **HDD Error:** Errors occurred during writing of the hard drive(s), no hard drive is installed, or the hard drive(s) failed to initialize.
- **Network Disconnected:** Disconnected network cable.
- **IP Conflict:** Conflict in IP address setting.
- **Illegal Login:** Incorrect user ID or password used.
- **Video Output Standard Mismatch:** Video output standards do not match each other.

To set exceptions:

1. Click **Menu** > **Settings** > **Exception** to enter the Exception menu.
2. Under **Exception Type**, select the exception that you want to configure.
3. Select triggering options (see [Figure 7-22](#)).



Figure 7-22 Exception Menu



## Understanding Exception Trigger Options

When setting up exception handles for such features as motion detection and relay alarms, you can select triggering options to alert you of these exceptions.

The triggering options include:

- **Pop-up Image on Monitor:** When an alarm is triggered, the local monitor (VGA or BNC monitor) will display an image in Live View mode. This alarm can be configured under the Popup Alarm Image handle method. For alarms that are triggered simultaneously, images will be displayed one at a time every 10 seconds (default dwell time). A different dwell time can be set by going to **Menu > Settings > Display > Dwell Time**. Once the alarm stops, cycling of the images will also stop and you will be returned to the Live View screen.
- **Audio Warning:** Trigger an audible beep when exception is detected.
- **Notify Surveillance Centre:** Sends a signal to remote alarm host when exception is detected (see [Configuring Remote Alarm Host Settings on page 77](#)).
- **Trigger Alarm Output:** Trigger an alarm output when an exception is detected. Alarm output can be configured by following the steps listed in [Sensor Alarm Settings](#).



# 8

## Network Settings

This chapter covers how to configure network settings.

---

### Configuring Network Settings

---

The network settings must be configured if the HRG DVR is used for monitoring over a network.

### Configuring General System Settings

To configure the general network settings:

1. Click **Menu** > **Settings** > **Network** to enter the Network Settings menu (see [Figure 8-1](#)).

**Figure 8-1 Network Settings Menu**

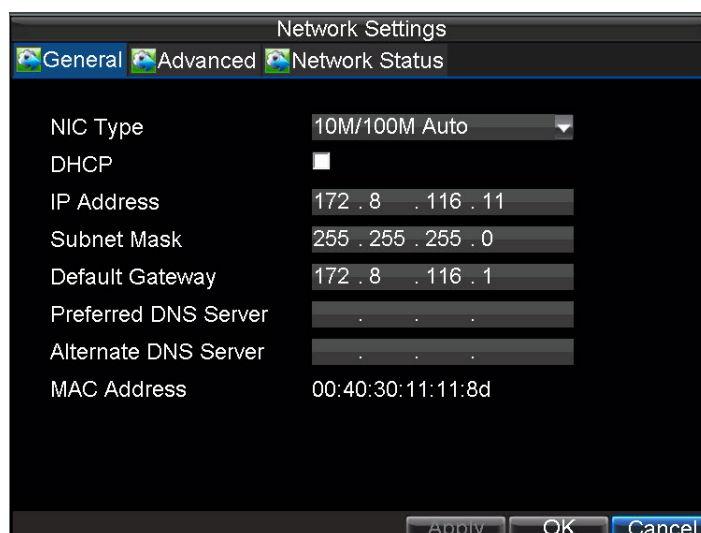

2. Select the **General** tab. Configure the settings on the interface.

3. If you want to configure your own settings, enter the settings for:
  - **IP Address:** IP address you would like to use for your HRG DVR.
  - **Subnet Mask:** Subnet Mask of network.
  - **Default Gateway:** IP address of your Gateway. Typically the IP address of your router.
  - **Preferred/Alternate DNS Server:** The preferred and alternate Domain Name System (DNS) Server to be used with your HRG DVR.
4. If you have a DHCP server running and would like your DVR to automatically obtain an IP address and other network settings from that server, select the DHCP check box. You can check the DHCP status by going to the Network Status tab (see [Figure 8-2](#)).

**Figure 8-2 Network Status**

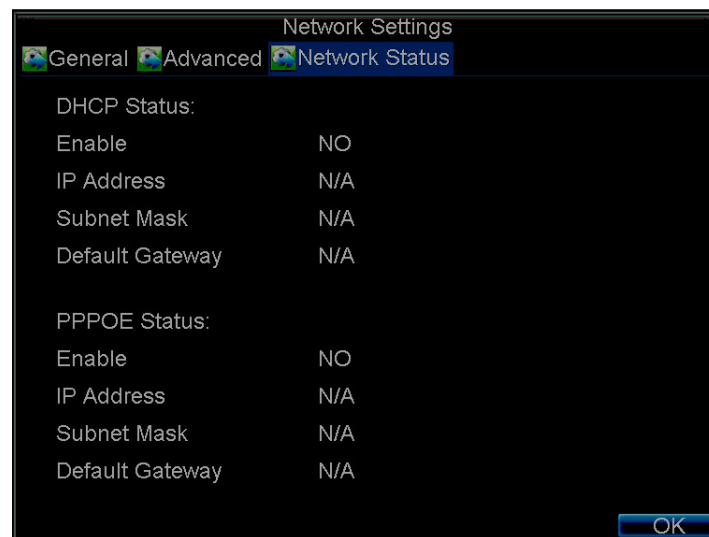

5. Click **OK** to save the settings and exit the menu.

## Configuring PPPoE Settings

Your DVR also allows for Point-to-Point Protocol over Ethernet (PPPoE) access.

To set up PPPoE access:

1. Click **Menu** > **Settings** > **Network** to enter the Network Settings menu.
2. Select the **Advanced** tab to enter the Advanced Network Settings menu (see [Figure 8-3](#)).

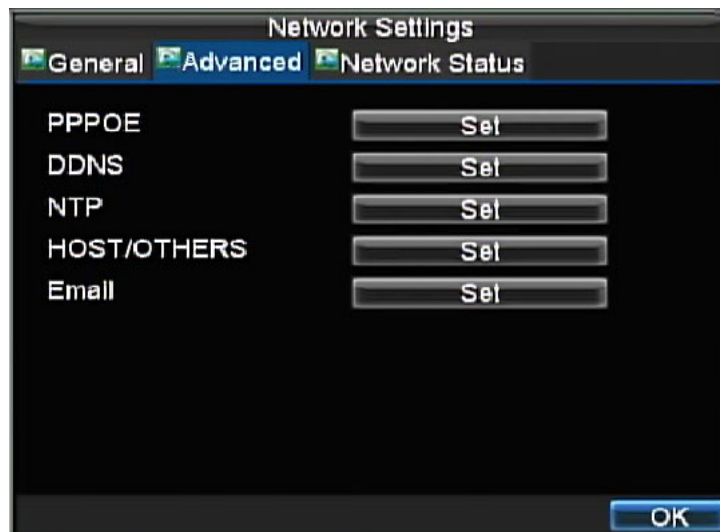
**Figure 8-3 Advanced Network Settings Menu**

3. Click **Set** next to **PPPOE** to enter the PPPoE Settings menu (see [Figure 8-4](#)).

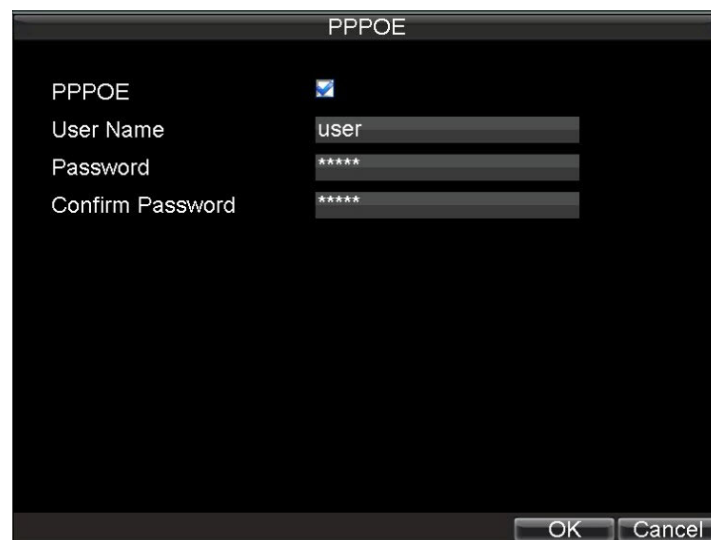
**Figure 8-4 PPPoE Settings**

4. Select the **PPPOE** check box to enable this feature.
5. Fill in the **User Name**, **Password**, and **Confirm Password** boxes, and then click **OK**.  
PPPOE credentials can be obtained from your network administrator. Once the setup is completed, your DVR will automatically dial-up into your network after reboot.
6. Click **OK** to save the settings and exit the menu.

You may be asked to restart your HRG DVR for the settings to take effect. To check on the status of your PPPoE connection, go to **Menu > Settings > Network** and select the **Network Status** tab.

## Configuring DDNS

If your DVR is set up to use PPPoE as its default network connection, you can set up Dynamic DNS (DDNS).

To set up DDNS:

1. Click **Menu** > **Settings** > **Network** to enter the Network Settings menu.
2. Select the **Advanced** tab.
3. Next to **DDNS**, click **Set** to enter the DDNS settings menu (see *Figure 8-5*).

**Figure 8-5 DDNS Settings Menu**

4. Select the **DDNS** check box to enable this feature.
5. Select the desired **DDNS Type** from the drop-down menu, and configure accordingly.

---

**Note** Configuration application notes for supported DDNS servers can be found on the **HRG Performance Series DVR** product webpage (<https://www.honeywellvideo.com/products/recorders/em/index.html>) in the **Product Literature** section.

---

## Configuring NTP Server Settings

A Network Time Protocol (NTP) Server can be set up on your HRG DVR to maintain the current date and time.

To set up an NTP server:

1. Click **Menu** > **Settings** > **Network** to enter the Network Settings menu.
2. Select the **Advanced** tab.
3. Next to **NTP**, click **Set** to enter the NTP Settings menu (see *Figure 8-6*).

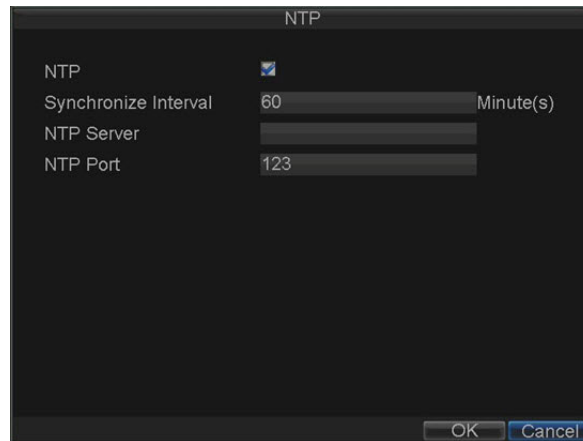
**Figure 8-6 NTP Settings Menu**

4. Select the **NTP** check box to enable this feature.
5. Configure the NTP settings:
  - **Synchronize Interval:** Time in minutes to synchronize with the NTP server.
  - **NTP Server:** Address of the NTP server.

---

**Note** The address can be set to the IP address or the domain name. When the domain name is used, please set the DNS server address.

---

6. Click **OK** to save the settings and exit the menu.

---

**Note** Time synchronization interval has a range of 0 to 10080 min, normally 7200 min. If the DVR is used on a public network, you should use an NTP server that has a time synchronization function, such as the server at the National Time Center (IP Address: 210.72.145.44). If the DVR is set up in a more customized network, NTP software can be used to establish an NTP server used for time synchronization.

---

## Configuring Remote Alarm Host Settings

With a remote alarm host set, the HRG DVR will send a signal to the host when an alarm is triggered. The remote alarm host must have the Network Video Surveillance software installed.

To set up a remote alarm host:

1. Click **Menu > Settings > Network** to enter the Network Settings menu.
2. Select the **Advanced** tab.
3. Next to **Host/Others**, click **Set** to enter the Host/Others menu (see [Figure 8-7](#)).

**Figure 8-7 Host/Others Menu**

HOST/OTHERS	
Alarm Host IP	<input type="text"/>
Alarm Host Port	<input type="text" value="0"/>
Server Port	<input type="text" value="8000"/>
HTTP Port	<input type="text" value="80"/>
Multicast IP	<input type="text" value="239 . 255 . 255 . 255"/>
<input type="button" value="OK"/> <input type="button" value="Cancel"/>	

4. Enter the **Alarm Host IP** and **Alarm Host Port**.

Alarm Host IP is the IP of the remote PC that has the Network Video Surveillance software installed. The Alarm Host Port must be the same as software's alarm monitor port (default port is 7200).

## Configuring Multicast

Setting up multicasting solves limitation issues when streaming video through a network access device. A multicast address spans the Class-D IP range of 224.0.0.0 to 239.255.255.255. It is recommended to use the IP address range from 239.252.0.0 to 239.255.255.255.

To set up multicasting:

1. Click **Menu** > **Settings** > **Network** to enter the Network Settings menu.
2. Select the **Advanced** tab.
3. Next to **Host/Others**, click **Set** to enter the Host/Others menu.
4. Set **Multicast IP** (see [Figure 8-8](#)).

When adding a device to the Network Video Surveillance software, the multicast address must be the same with the DVR's multicast IP.

**Figure 8-8 Host/Others Menu**

HOST/OTHERS	
Alarm Host IP	<input type="text"/>
Alarm Host Port	<input type="text" value="0"/>
Server Port	<input type="text" value="8000"/>
HTTP Port	<input type="text" value="80"/>
Multicast IP	<input type="text" value="239 . 255 . 255 . 255"/>
<input type="button" value="OK"/> <input type="button" value="Cancel"/>	



5. Click **OK** to save the settings and exit the menu.

## Configuring Server and HTTP Ports

If you would like to change the server and HTTP ports from the default settings, you can do so in the Network Settings menu. The default server port is 8000 while the default HTTP port is 80.

To change the default ports:

1. Click **Menu** > **Settings** > **Network** to enter the Network Settings menu.
2. Select the **Advanced** tab.
3. Next to **Host/Others**, click **Set** to enter the Host/Others menu.
4. Enter new **Server Port** and **HTTP Port** (see [Figure 8-9](#)).

**Figure 8-9** Host/Others Menu

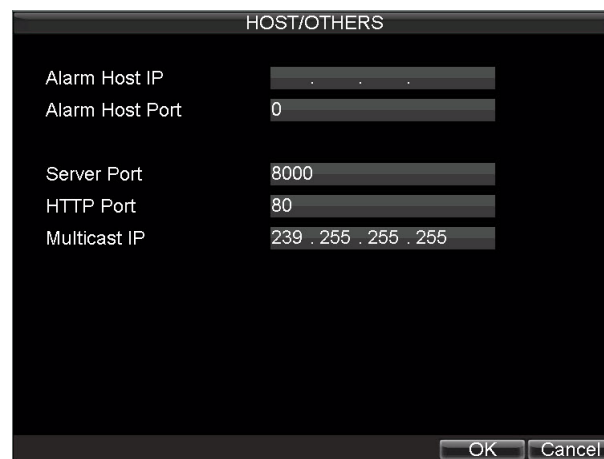

---

**Note** The Server Port has a port range of 2000 to 65535 and is used for remote client software access. The HTTP port is used for remote Internet browser access.

---

## Configuring Email

You can configure your HRG DVR to send email notifications to all designated users if an alarm event or motion event is detected.

Before configuring the email settings, ensure that your DVR is connected to a local area network (LAN) that maintains an SMTP mail server. The network must also be connected to either an intranet or the Internet, depending on the location of the email accounts to which you want to send notification.

To configure the email settings:

1. Click **Menu** > **Settings** > **Network** to enter the Network Settings menu.
2. Select the **Advanced** tab.
3. Click **Set** next to Email to enter the Email settings menu.

Figure 8-10 Email Settings Menu

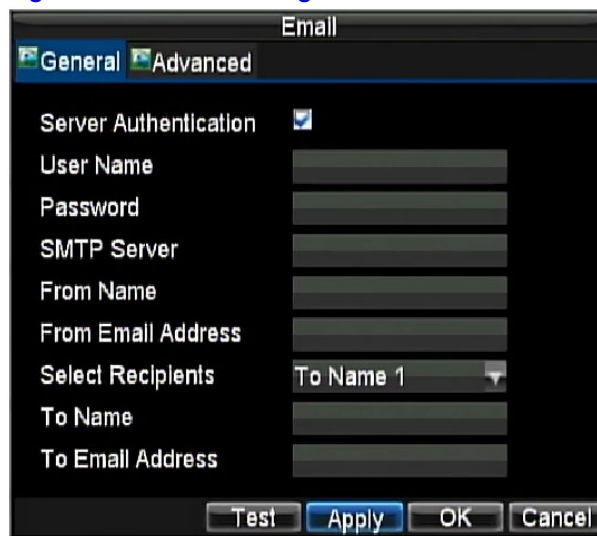

4. Configure the following email settings:
  - **Server Authentication (optional):** Check to enable server authentication.
  - **User Name:** Enter the sender's email user account for SMTP server authentication.
  - **Password:** Enter the sender's email password for SMTP server authentication.
  - **SMTP Server:** Enter the SMTP server IP address or host name. (For example, smtp.263xmail.com.)
  - **From Name:** Enter the sender's name.
  - **From Email Address:** Enter the sender's email address.
  - **Select Recipients:** Select the receiver. Up to 3 receivers can be configured.
  - **To Name:** Enter the name of the user who is to receive the notification email.
  - **To Email Address:** Enter the email address of the user who is to receive the notification email.
5. Click **Apply** to save the Email settings.

# 9

## PTZ Control

This chapter describes how to configure and use the HRG Performance Series DVR to control PTZ Dome cameras in your network system.

---

### Navigating the PTZ Menu

---

PTZ menus can be navigated using either the mouse or the front panel/remote. For quick access to certain PTZ settings, click the right mouse button in Live View mode, and then click **PTZ** to enter PTZ control mode (see [Using the Mouse in Live View on page 34](#)). While in PTZ control mode, right-click anywhere in the window to see the PTZ menu (see [Figure 9-1](#)).

**Figure 9-1** PTZ Menu

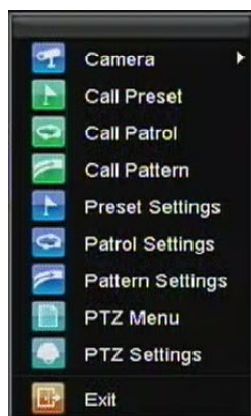

Menu items include:

- **Camera:** Select a PTZ camera.
- **Call Preset:** Call a PTZ preset.
- **Call Patrol:** Call a PTZ sequence.
- **Call Pattern:** Call a PTZ pattern.
- **Preset Settings:** Enter PTZ preset configuration menu.
- **Patrol Settings:** Enter PTZ sequence configuration menu.
- **Pattern Settings:** Enter PTZ pattern configuration menu.
- **PTZ Menu:** Enter PTZ control menu.
- **PTZ Settings:** Enter PTZ settings menu.

---

## Configuring PTZ Settings

---

Settings for a PTZ camera must be configured before it is used. Before proceeding, verify that the PTZ and RS-485 of the DVR are connected properly.

To configure PTZ settings:

1. Click **Menu** > **Settings** > **PTZ** to enter the PTZ Settings menu (see [Figure 9-2](#)).

**Figure 9-2** PTZ Settings Menu



2. Next to **Camera**, select the channel where PTZ camera is installed.
3. Set the **Baudrate**, **Data Bit**, **Stop Bit**, **Parity**, **Flow Control**, **PTZ Protocol**, and **Address**.
4. Click **OK** to save the settings and exit the menu.

---

**Note** All setting parameters (baud rate, data bit, stop bit, parity, flow control, PTZ protocol and address) must be consistent with the PTZ camera connected.

---

---

## Setting PTZ Presets, Patrols and Patterns

---

The HRG DVR allows you to program presets, patrols, and patterns for a connected PTZ camera.

### Understanding PTZ Controls

The PTZ control panel provides a series of PTZ controls (see [Figure 9-3](#)).

**Figure 9-3 PTZ Control Panel**

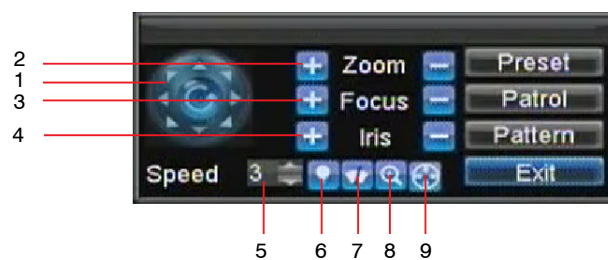

The controls on the panel include:

1. **Directional Pad/Auto-scan Buttons:** Controls the movements and directions of the PTZ. The center button is also used to start the auto-scan of the PTZ.
2. **Zoom:** Used to zoom in and out with the PTZ.
3. **Focus:** Used to adjust the focus of the PTZ.
4. **Iris:** Used to open up or close the iris of the PTZ.
5. **Speed:** Adjusts the movement speed of the PTZ.
6. **Light:** Turns the PTZ light (if applicable) on and off.
7. **Wiper:** Turns the PTZ wiper (if applicable) on and off.
8. **Zoom In:** Instantly zooms the PTZ in.
9. **Center:** Centers the PTZ.

### Customizing Presets

Presets can be set to move your PTZ camera to a desired preset location.

To set up and call custom PTZ presets:

1. Open the PTZ Control panel ([Figure 9-3](#)) by selecting **PTZ** in the right-click menu or by pressing **PTZ** on the front panel of the DVR.
2. Click **Preset** to enter the Preset Management menu.
3. In the Preset Management menu (see [Figure 9-4](#)) you can:
  - **Configure Preset:** Use the PTZ control panel to adjust the position of the preset. Select a Preset number and click **Set** to save preset location.
  - **Clear Preset:** Select a Preset number and click **Clear** to delete the preset. You can also click **Clear All** to delete all presets.
  - **Call Preset:** Select a Preset and click **Call**.

**Figure 9-4 Preset Management Menu**



---

**Note** Only valid presets can be called and deleted.

---

## Customizing Patrols

Patrols can be programmed to move the PTZ to different key points and make it stay there for a defined duration before moving on to the next point. The key points are defined by presets which can be set by following the steps above in [Customizing Presets](#).

To set up and call PTZ patrols:

1. Open the PTZ Control panel ([Figure 9-3](#)), by clicking **PTZ** in the mouse menu or by pressing **PTZ** on the front panel of the DVR.
2. Click **Patrol** to enter the Patrol Management menu (see [Figure 9-5](#)).

**Figure 9-5 Patrol Management Menu**



3. In the Patrol Management menu, you can configure a patrol:
  - a. Select a **Patrol Number** to set.
  - b. Select valid presets (See [Customizing Presets](#)), and then click **Set** to enter the Patrol Configuration menu. A sequence should have at least two valid presets.
  - c. Set the **KeyPoint No.**, **Duration**, and **Speed** (see [Figure 9-6](#)).

The KeyPoint Number determines the order the PTZ will follow when cycling through the patrol. The Duration refers to the time span to stay at the corresponding keypoint. The Speed defines the rate at which the PTZ will move to the current preset.

**Figure 9-6 Patrol Configuration Menu**



4. Click **OK** to return to the Patrol Management menu and repeat [step 2](#) and [step 3](#) to configure other keypoints.
5. After all keypoints have been configured, click the defined **KeyPoint Number**, and then click **Add** to complete the setting.
6. Click **OK** to save the settings and exit the current menu.

To clear a PTZ patrol:

1. In the Patrol Management menu ([Figure 9-5](#)), select a valid Patrol Number.
2. Click **Clear** to delete the patrol.

To call a PTZ patrol:

1. In the Patrol Management menu ([Figure 9-5](#)), select a valid Patrol Number.
2. Click **Start** to call the patrol, and then click **Stop** to stop the patrol (see [Figure 9-7](#)).

**Figure 9-7 Patrol Management Menu**

## Customizing Patterns

Patterns can be set up by recording the movement of the PTZ.

To set up and call PTZ patterns:

1. Open the PTZ Control panel ([Figure 9-3](#)), by clicking **PTZ** in the mouse menu or by pressing **PTZ** on the front panel of the DVR.
2. Click **Pattern** to enter the Pattern Management menu (see [Figure 9-8](#)).

**Figure 9-8 Pattern Management Menu**

3. Select a **Pattern Number**.
4. To record a new pattern, click **Run Record** to start recording the movements of the PTZ. Use the PTZ control panel to move the PTZ. The PTZ movements are recorded until **Stop Record** is clicked.
5. To run a pattern, click **Run Pattern** on a valid pattern. The PTZ moves according to the path that was defined until **Stop Pattern** is clicked.
6. Click **OK** to exit the menu.



# 10

## Camera Management

This chapter covers OSD settings, image settings, and privacy mask settings.

---

### OSD Settings

---

Use the Camera Management menu to configure on-screen display (OSD) settings. The OSD is shown in each display during Live View mode and includes the time and date as well as the camera name.

To configure OSD settings:

1. Click **Menu** > **Settings** > **Camera** to enter the Camera Settings menu (see [Figure 10-1](#)).
2. Select the channel to set up the OSD settings in the **Camera** drop-down list and then click **Set**.
3. Configure the desired OSD settings (see [Figure 10-1](#)).

**Figure 10-1** Camera Settings Menu

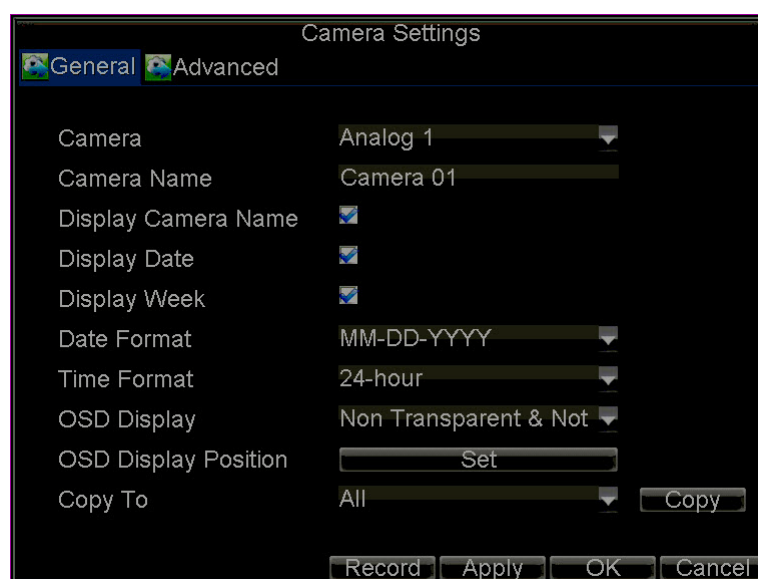

4. Click **Set** to modify the OSD display position, including the camera name position and the date/time display position.

## Image Settings

Image settings such as the brightness, contrast, saturation and hue can also be adjusted in the Camera Management menu.

To adjust image settings:

1. Click **Menu** > **Settings** > **Camera** to enter the Camera Settings menu (see [Figure 10-1](#)).
2. Select the **Advanced** tab to enter the Advanced Camera Settings menu (see [Figure 10-2](#)).

**Figure 10-2 Advanced Camera Settings Menu**

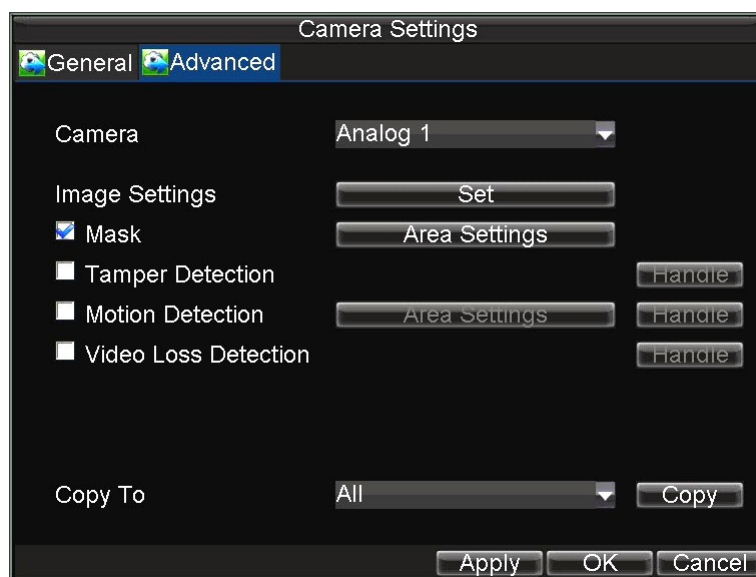

3. Select the channel for image settings in the **Camera** drop-down list.
4. Next to **Image Settings**, click **Set**.
5. Adjust the image settings (see [Figure 10-3](#)).

You can adjust brightness, contrast, saturation, and hue in the menu. The adjustments of image settings will affect the live images and the recorded images.

**Figure 10-3 Image Settings**



## Privacy Mask Settings

You can set up privacy mask to mask off sensitive or private areas in the field of view of a camera.

To set up a privacy mask:

1. Click **Menu** > **Settings** > **Camera** to enter the Camera Settings menu.
2. Select the **Advanced** tab to enter the Advanced Camera Settings menu (see [Figure 10-4](#)). Select the channel for privacy mask settings in the **Camera** drop-down list.

**Figure 10-4** Advanced Camera Settings Menu

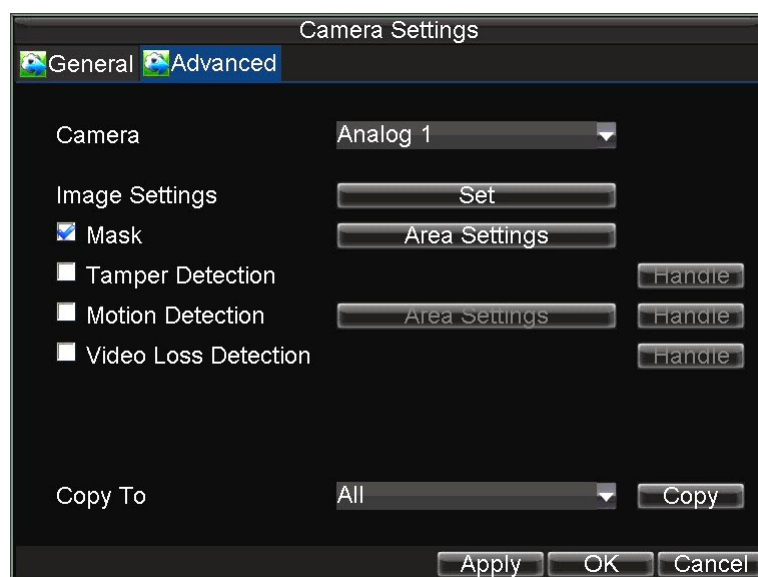

3. Select the **Mask** check box to enable the feature.
4. Click **Area Settings** to enter the Area Settings menu.
5. Set the mask area (see [Figure 10-5](#)). You can configure up to four areas.

**Figure 10-5** Setting Mask Area



6. Click **Exit** to save the settings and exit the Mask Area Settings interface.



# 11

## Hard Drive Management

This chapter covers how to configure and manage the hard drive(s) of the HRG Performance Series DVR.

---

### Managing Hard Drives

---

#### Initializing Hard Drives

A newly installed hard disk drive (HDD) must be first initialized before it can be used with your HRG DVR. Initializing the HDD will erase all data on it.

To initialize a HDD:

1. Click **Menu** ► **HDD** to enter the HDD Management menu (see [Figure 11-1](#)).

**Figure 11-1** HDD Management Menu

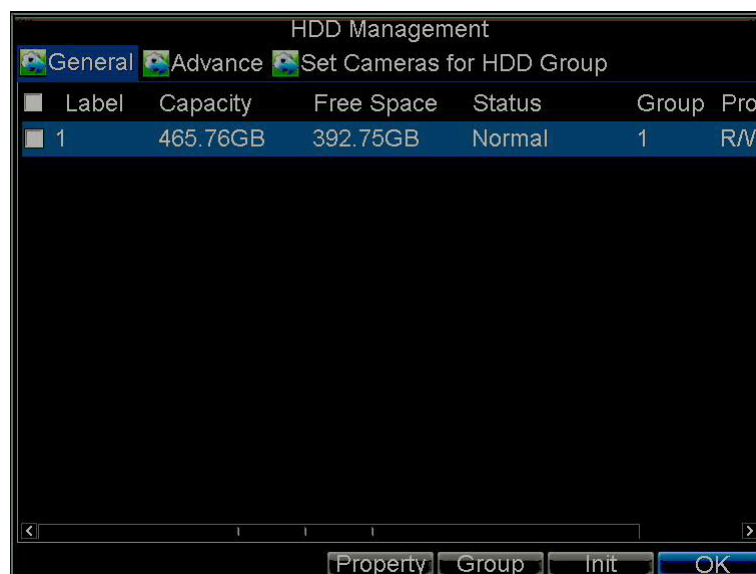

2. Select the hard drive (HDD) that you want to initialize.
3. Click **Init**.

4. Click **OK** to start the initialization process.

After the HDD has been initialized, the status of the HDD will change from **Abnormal** to **Normal**.

## Setting HDD Groups

Your HRG DVR can separate multiple HDDs into groups. Video from specified channels can be recorded to a particular HDD group.

To set up an HDD group:

1. Click **Menu** ► **HDD** to enter the HDD Management menu.
2. Select the HDDs to be added to the group.
3. Click **Group** to enter the Group Settings menu (see [Figure 11-1](#)).
4. Set the HDD Group Number (see [Figure 11-2](#)).

**Figure 11-2 HDD Group Settings Menu**

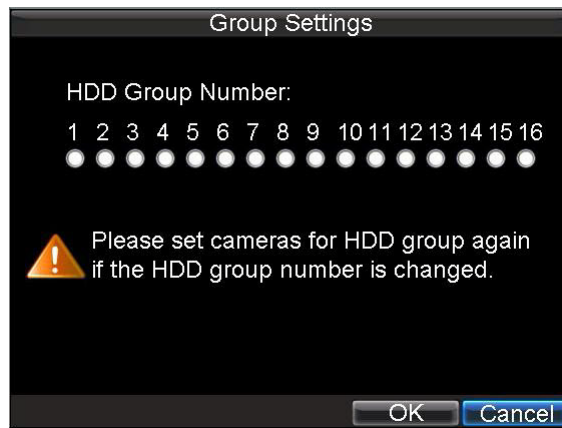

5. Click **OK** to save settings and exit the Group Settings menu.

---

**Note** By default, all HDDs belong to Group 1.

---

## Setting HDD Status

You can change the behavior of your HDD by changing its status. The status of a HDD can be set to read-only or read/write (R/W).

### Setting an HDD to Read-Only

A HDD can be set to read-only to avoid important recorded files from being overwritten when the HDD becomes full.

To set a HDD to read-only:

1. Click **Menu** ► **HDD** to enter the HDD Management menu.
2. Select the HDD to be protected.

3. Click **Property** to enter the Property Settings menu (see [Figure 11-3](#)).

**Figure 11-3 HDD Property Settings Menu**



4. Set HDD Status to **Read-Only**.
5. Click **OK** to save the settings and exit the current menu.

---

**Note** Once set to read-only, the HDD cannot be written to until it is set back to read/write (R/W).

Your DVR can be installed with one HDD only; therefore, when the property is set to read-only, the recording of the device will be stopped.

---

## Checking HDD Status

You can check the status of the installed HDDs on your HRG DVR at any time.

To check the status of a HDD:

- Click **Menu** > **HDD** to enter the HDD Management menu.  
The status of your HDD is listed under the **Status** column.
  - A **Normal** or **Hibernate** status indicates that the HDD is in working order.
  - If the status is listed as **Abnormal** and has already been initialized, the HDD needs to be replaced. If the HDD is uninitialized, you need to initialize it before it can be used in your HRG DVR. Please see [Initializing Hard Drives on page 101](#) for further instructions.

## Using the SMART Function

You can also view the SMART information of the installed HDD. SMART (Self-Monitoring, Analysis and Reporting Technology) is a monitoring system for hard disk drives to detect and report on various indicators of reliability in the hopes of anticipating failures.

To view SMART information of an HDD:

1. Click **Menu** > **Maintenance** > **Log Search** to enter the Log Search menu (see [Figure 11-4](#)).

**Figure 11-4 Log Search Menu**

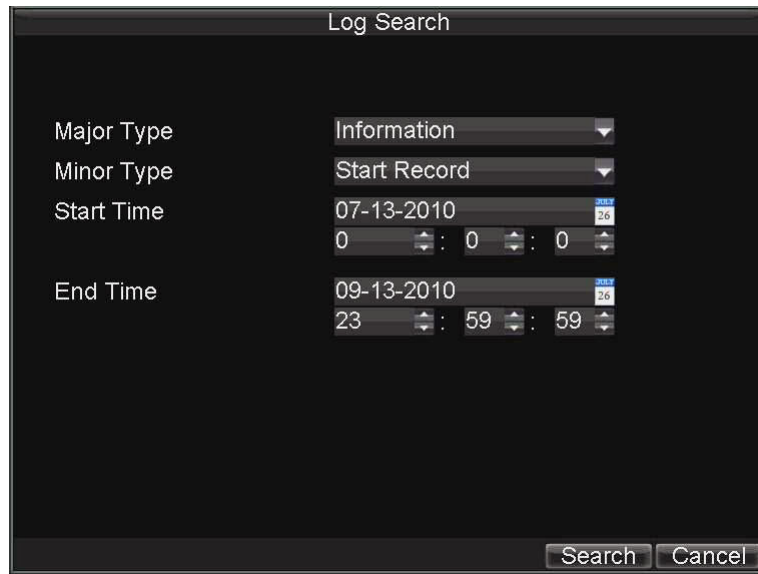

2. Set the **Major Type** field to **Information**.
3. Set the **Minor Type** field to **HDD SMART**.
4. Enter the desired times in the **Start Time** and **End Time** fields.
5. Click **Search** to begin the log search.

A list of results similar to that of [Figure 11-5](#) are displayed.

**Figure 11-5 Log Search Results**



6. Select the log item to view and click **Details**.  
A detailed list of SMART information will be displayed (see [Figure 11-6](#)).

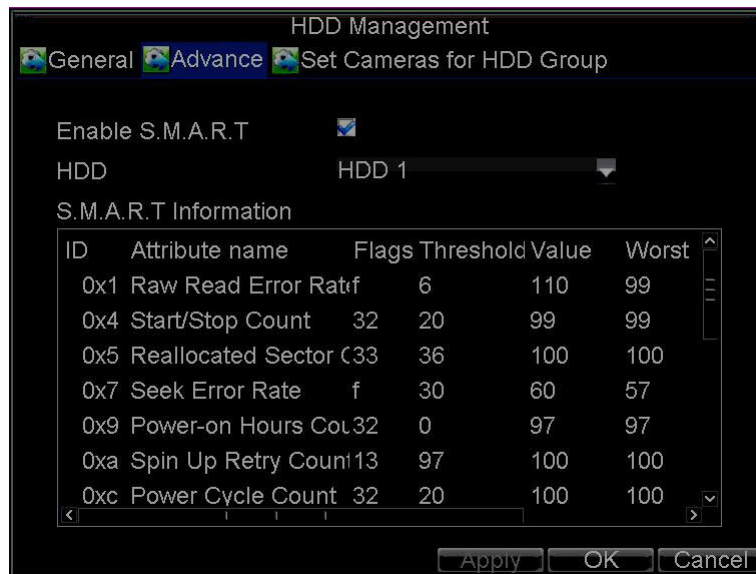

**Figure 11-6 HDD SMART Information**



You can also click **Menu** > **HDD** to enter the HDD management menu (see [Figure 11-2](#)), and then select the **Advance** option to enter the SMART menu (see [Figure 11-7](#)). You can enable the SMART function and view the SMART information as well.

**Figure 11-7 HDD SMART Menu**



## Configuring HDD Alarms

You can set HDD alarms to trigger when an HDD is uninitialized or in an abnormal state.

To set HDD alarms:

1. Click **Menu** > **Settings** > **Exception** to enter the Exception menu (see [Figure 11-8](#)).

**Figure 11-8 Exception Menu, HDD Error**

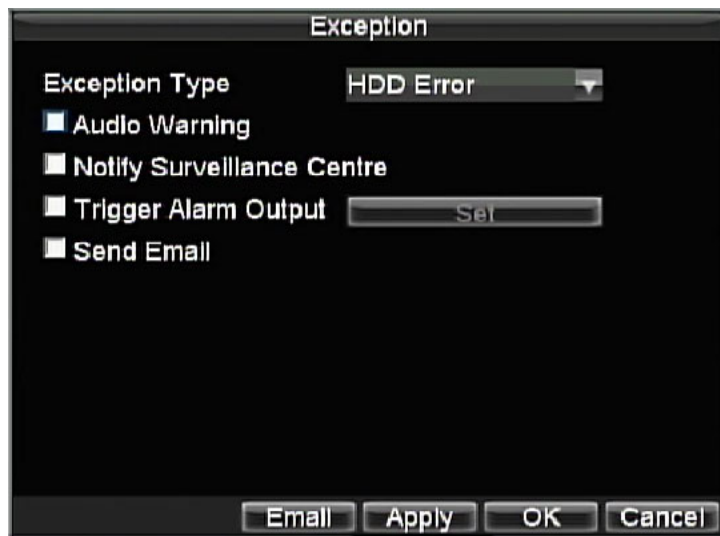

2. Set the **Exception Type** drop-down list to **HDD Error**.
3. Select the **Trigger Action Output** check box. Trigger actions are further explained in [Understanding Exception Trigger Options on page 71](#).

# 12

## HRG DVR Management

This chapter describes how to configure system settings and manage user accounts. It also covers how to update system firmware, restore default settings, and view system information.

---

### Configuring System Settings

---

#### Configuring General Settings

Use the General Settings menu to configure general settings such as the system language.

To configure general settings:

1. Click **Menu** > **Settings** > **General** to enter the General Settings menu (see [Figure 12-1](#)).

**Figure 12-1** General Settings Menu

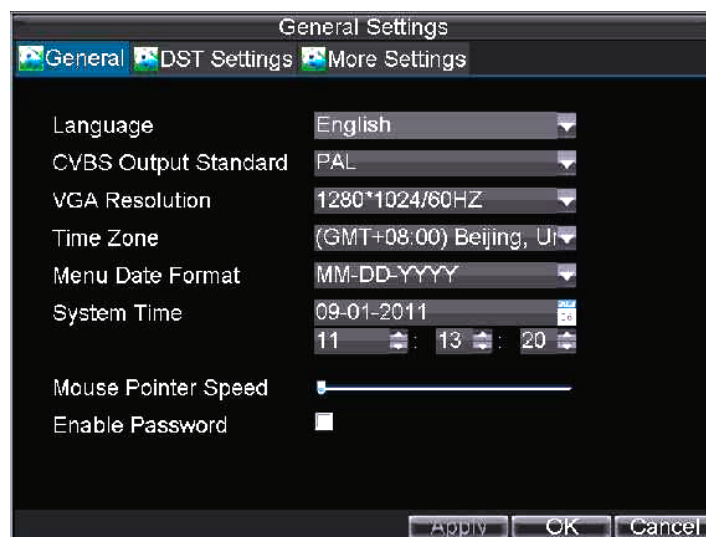

2. Select the **General** tab.

3. Configure general settings, including:
  - **Language:** Default language used in all the HRG DVR menus.
  - **CVBS Output Standard:** Video output standard: NTSC and PAL.
  - **VGA Resolution:** VGA output resolution. 1024 × 768/60HZ and 1280 × 1024/60HZ resolution is selectable.
  - **Time Zone:** Time zone that you want the DVR to use.
  - **Menu Date Format:** Format for date.
  - **System Time:** System time and date.
  - **Mouse Pointer Speed:** Speed of mouse pointer.
  - **Enable Password:** Enable/disable system password.

---

**Note** If the video standard is different between the input and the output, you may notice flickering in Live View mode. After modifying the video standard, please reboot the DVR to validate the settings.

---

## Configuring Advanced Settings

To configure more advanced system settings:

4. Click **Menu** > **Settings** > **General** to enter the General Settings menu (see [Figure 12-1](#)).
5. Select the **More Settings** tab to enter the More Settings menu (see [Figure 12-2](#)).

**Figure 12-2 More Settings Menu**

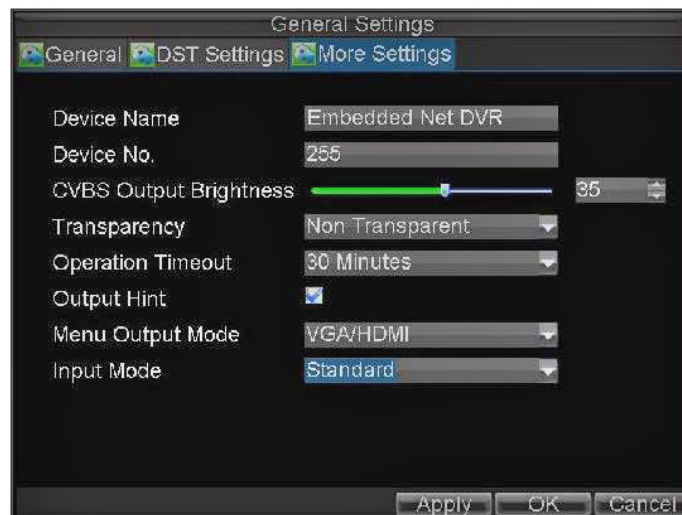

6. Configure the following settings:
  - **Device Name:** Name of the HRG DVR used.
  - **Device No.:** Device number of the HRG DVR.
  - **CVBS Output Brightness:** Video output brightness. Level 0 to 63 can be configurable.
  - **Transparency:** Menu transparency.
  - **Operation Timeout:** Set the timeout time for menu inactivity. For example, if timeout time was set to five minutes, after five minutes of inactivity in the General Settings menu, you are returned to the Live View.
  - **Output Hint:** Enable/disable video output hint for main or aux video output.
  - **Menu Output Mode:** Select the menu output mode to **Auto**, VGA/HDMI or CVBS. When **Auto** is selected, the system automatically detects whether the VGA/HDMI or CVBS interface is connected.
  - **Input Mode:** Set the video input mode to **Standard** or **Gentle**.

---

## Setting the RS-232 Port

---

To configure RS-232 devices to be used with the DVR:

1. Click **Menu** > **Settings** > **RS232** to enter the RS-232 Settings menu (see [Figure 12-3](#)).

**Figure 12-3 RS-232 Settings Menu**

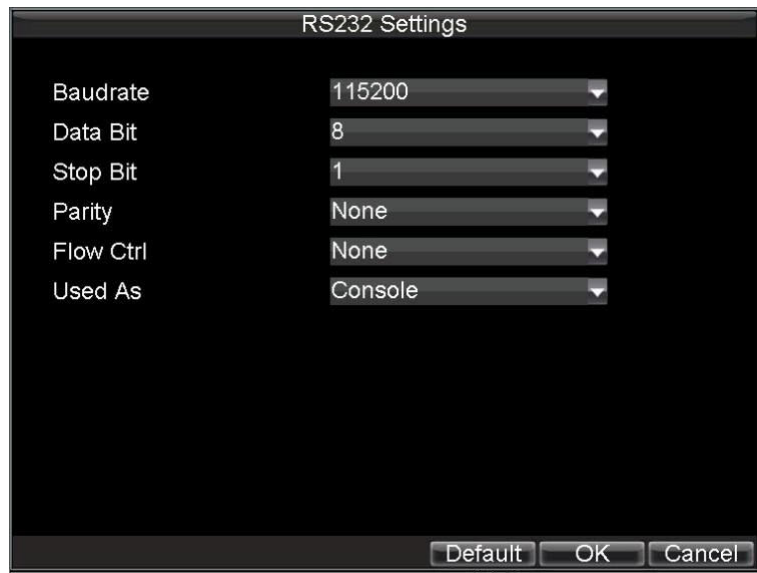

2. Configure the RS-232 settings.

3. The RS-232 port can be used in two ways:
  - **Parameter Control:** Connect a PC to the HRG DVR using the PC serial port. You can then set device parameters using software such as HyperTerminal. The serial port parameters must be the same as the DVR's when connecting with the PC serial port.
  - **Transparent Channel:** Connect a serial device directly to the HRG DVR. The serial device will be controlled remotely by the PC through the network and the protocol of the serial device.

---

## Managing User Accounts

---

By default your Performance Series DVR is configured with the user name of **admin** and password **12345**. The Administrator has the authority to add, delete, or configure the user parameters.

### Adding a New User

To add a new user:

1. Click **Menu** > **Settings** > **User** to enter the User Settings menu (see [Figure 12-4](#)).

**Figure 12-4 User Settings Menu**

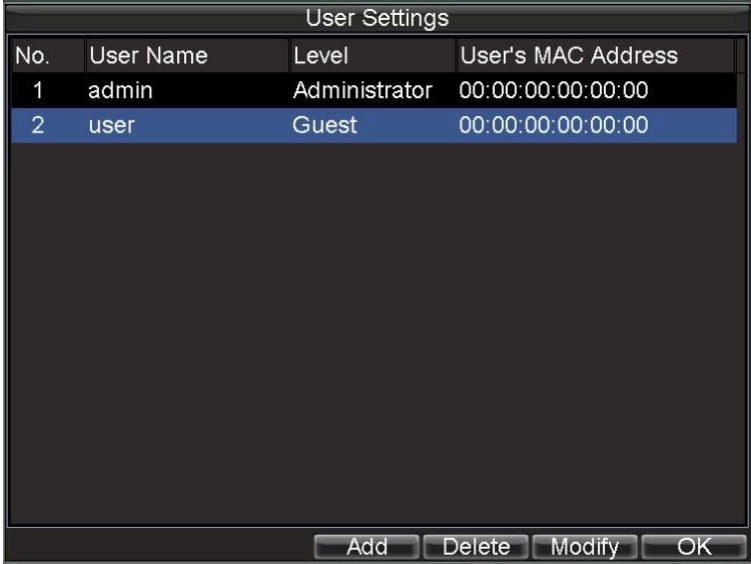

No.	User Name	Level	User's MAC Address
1	admin	Administrator	00:00:00:00:00:00
2	user	Guest	00:00:00:00:00:00

Add Delete Modify OK

2. Click **Add** to enter the Add User menu (see [Figure 12-5](#)).  
You can add up to 31 users.

Figure 12-5 Add User Menu

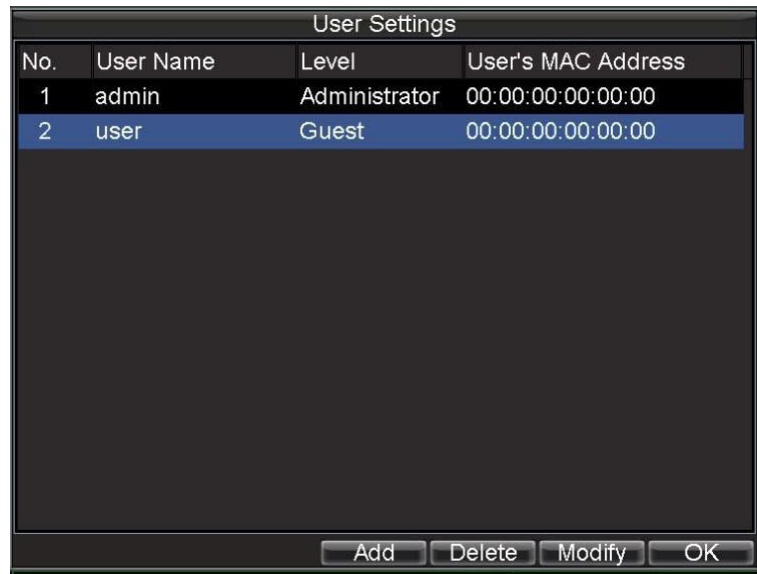

3. Enter information for the new user, including **User Name**, **Password**, **Level**, and **User's MAC Address**.
4. The **Level** is the user level and is separated into two tiers:
  - **Operator**: By default, the Operator user level has the authority to configure two-way audio in network settings and all parameters in channel settings.
  - **Guest**: By default, the Guest user level cannot configure network settings, but can configure the local playback as well as the remote playing in channel settings.
5. If the **User's MAC Address** is configured and enabled, the user may only access the HRG DVR from that particular MAC address.
6. Click **Permission** to enter the Permission Settings menu (see [Figure 12-6](#)).

Figure 12-6 Permission Settings Menu

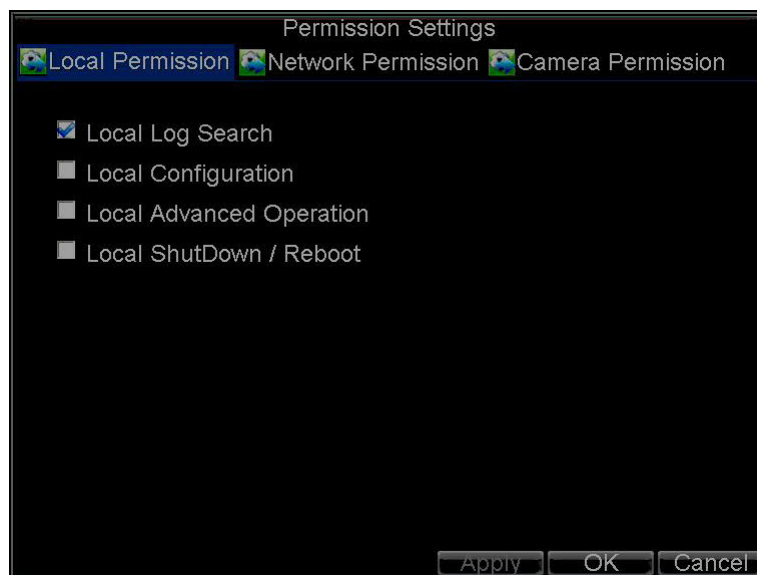

7. Configure permission for local settings on the **Local Permission** tab.

The local settings include:

- **Local Log Search:** Search and view logs of HRG DVR.
  - **Local Configuration:** Configure and restore parameters to factory defaults. Introduce settings to or export settings from HRG DVR.
  - **Local Advanced Operation:** HDD management (including the initialization and changing the properties of a disk). Ability to update system firmware as well as to stop the relay output
  - **Local Shutdown/Reboot:** Shut down or reboot the HRG DVR.
8. Select the **Network Permission** tab to configure network permission settings (see [Figure 12-7](#)).

**Figure 12-7 Network Permission Settings Menu**

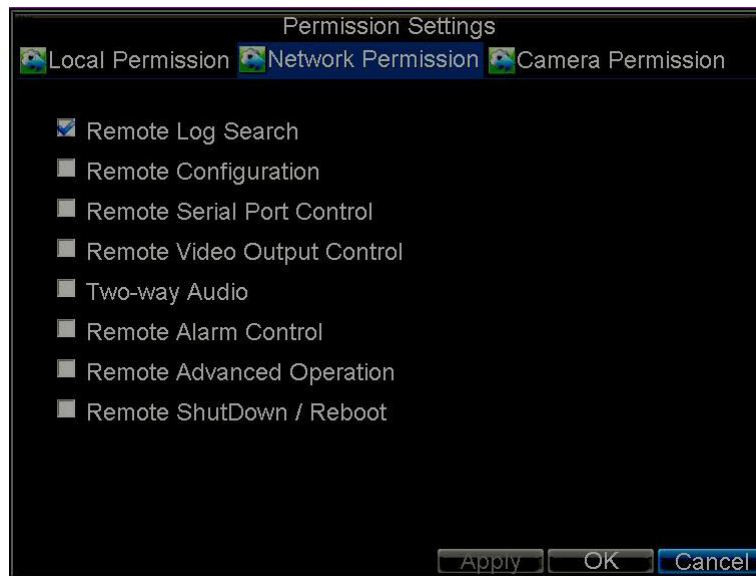

The network settings include:

- **Remote Log Search:** Remotely view logs that are saved on the HRG DVR.
  - **Remote Configuration:** Remotely configure parameters, restore parameters to factory defaults and import settings to as well as export settings from the HRG DVR.
  - **Remote Serial Port Control:** Configure settings for RS232 and RS-485 ports.
  - **Remote Video Output Control:** Configure settings for video output.
  - **Two-way Audio:** Permission to use two-way radio between the remote client and the DVR.
  - **Remote Alarm Control:** Remote alert or control the relay output of the HRG DVR. Alarm and exception settings must be configured properly to upload to host.
  - **Remote Advanced Operation:** Remotely manage hard disk drives (initializing and setting properties for HDDs). Permission to remotely update system firmware and stop relay output.
  - **Remote Shutdown/Reboot:** Remotely shut down or reboot the HRG DVR.
9. Select the **Camera Permission** tab to configure channel permission (see [Figure 12-8](#)).



**Figure 12-8 Camera Permission Settings Menu**

The channel settings include:

- **Remote Live View:** Select and view live video over the network.
  - **Local Manual Record:** Locally start and stop manual recording on any of the channels.
  - **Remote Record Starting:** Remotely start and stop manual recording on any of the channels.
  - **Local Playback:** Locally play recorded files that are on the HRG DVR.
  - **Remote Playback:** Remotely play and download recorded files that are on the HRG DVR.
  - **Local PTZ Control:** Locally control PTZ cameras.
  - **Remote PTZ Control:** Remotely control PTZ cameras.
  - **Local Video Export:** Locally back up recorded files from any of the channels.
10. Click **OK** to save the settings and exit the menu.

---

**Note** If you forget the password to your HRG DVR, contact your supplier with the serial number of the HRG DVR to obtain a secure code to reset your HRG DVR.

---

## Deleting a User

To delete a user from the HRG DVR:

1. Click **Menu** > **Settings** > **User** to enter the User Settings menu.
2. Select the user you want to delete.
3. Click **Delete** to confirm the deletion.
4. Click **OK** to exit the menu.

---

**Note** The Administrator cannot be deleted.

---

## Modifying a User

To modify a user:

1. Click **Menu** > **Settings** > **User** to enter the User Settings menu.
2. Select the user you want to modify.
3. Click **Modify** to enter the Modify menu (see [Figure 12-9](#)).

**Figure 12-9** Modify User Menu

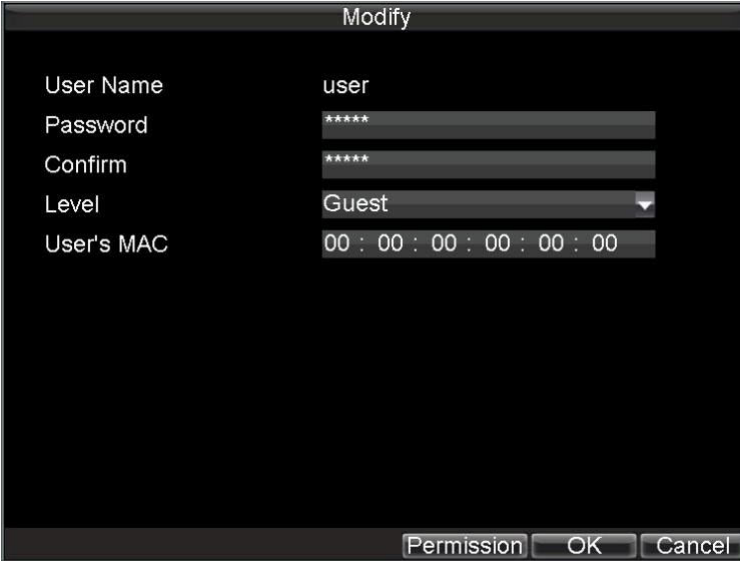

User Name	user
Password	*****
Confirm	*****
Level	Guest
User's MAC	00 : 00 : 00 : 00 : 00 : 00

Permission OK Cancel

4. Edit the user information.
5. To modify user permissions, click **Privileges**. Permissions settings are defined in the Adding a New User section described above.
6. Click **OK** to exit the menu.

---

## Managing the System

---

### Importing and Exporting the Configuration File

Configuration information from your HRG DVR can be exported to a USB device and imported into another DVR. This will allow you to efficiently setup the same configuration on numerous HRG DVRs.

To import or export HRG DVR configuration:

1. Click **Menu** > **Maintenance** > **Configuration** to enter the Import/Export Configuration menu (see [Figure 12-10](#)).

**Figure 12-10 Import/Export Configuration Menu**

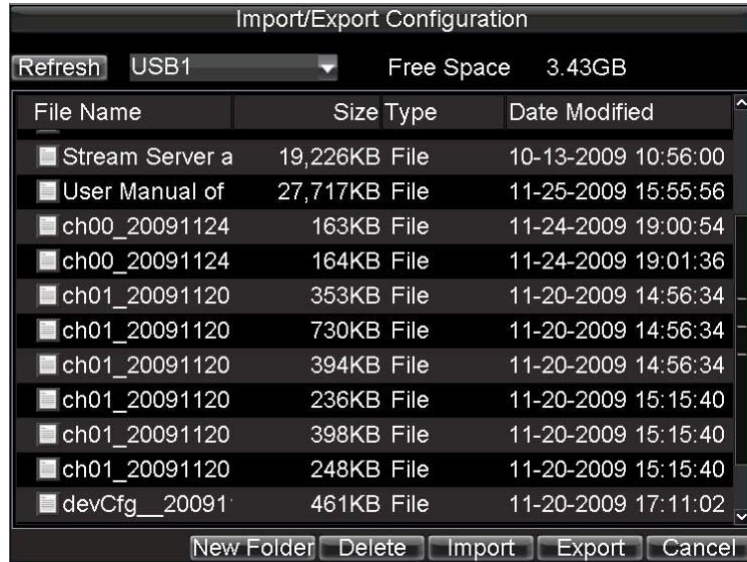

2. Click **Export** to export a configuration file to USB device. USB device must be connected at this point to the HRG DVR.
3. To import a configuration file, select the file from the USB device, and then click **Import**.
4. After the import process is completed, the system will automatically reboot the HRG DVR.
5. Click **Cancel** to exit the current menu.

---

## Updating the System Firmware

---

The firmware on your HRG DVR can be updated using two methods: you can update via a USB device or over the network via an FTP server.

To update via a USB device:

1. Connect the USB device to the HRG DVR. The firmware file must be located in the root directory of your USB device.
2. Click **Menu** > **Maintenance** > **Upgrade** to enter the Firmware Update menu (see [Figure 12-11](#)).

**Figure 12-11 Firmware Update Menu**

3. Select the **Local Upgrade** tab.
4. Select the firmware on the USB device.
5. Click **Upgrade** to begin the update process.
6. After the system firmware has been updated, reboot the DVR to complete the upgrade process.

To update via an FTP server:

1. Configure the PC (running the FTP server) and the HRG DVR to be in the same Local Area Network (LAN). Run the third-party TFTP software on the PC and then copy the firmware to the root directory of TFTP.
2. Click **Menu > Maintenance > Upgrade** to enter the Firmware Update menu.
3. Select the **FTP** tab (see [Figure 12-12](#)).

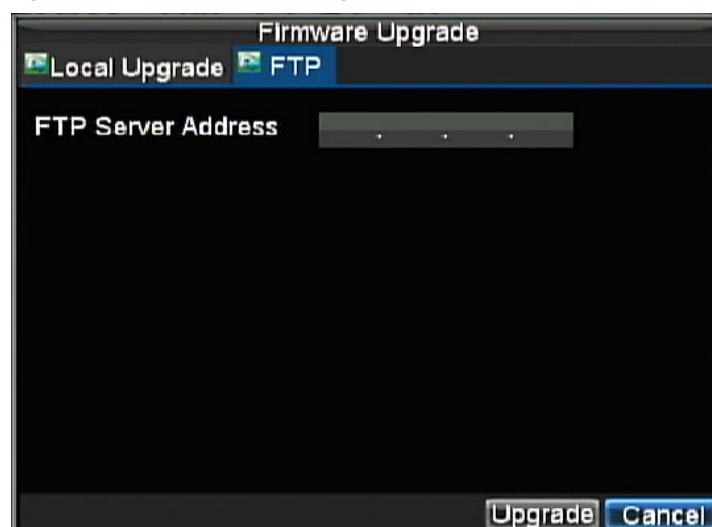
**Figure 12-12 FTP Firmware Update**

4. Input the FTP server address.
5. Click **Upgrade** to begin the update process.
6. After the system firmware has been updated, reboot the HRG DVR to complete the update process.

---

**Note** If the HRG DVR fails to update, please contact your system supplier for further assistance.

---

---

## Restoring the Default Settings

---

To restore the default factory settings to your HRG DVR:

1. Click **Menu** > **Maintenance** > **Default** to enter the Default Settings menu (see *Figure 12-13*).

**Figure 12-13 Default Settings Menu**

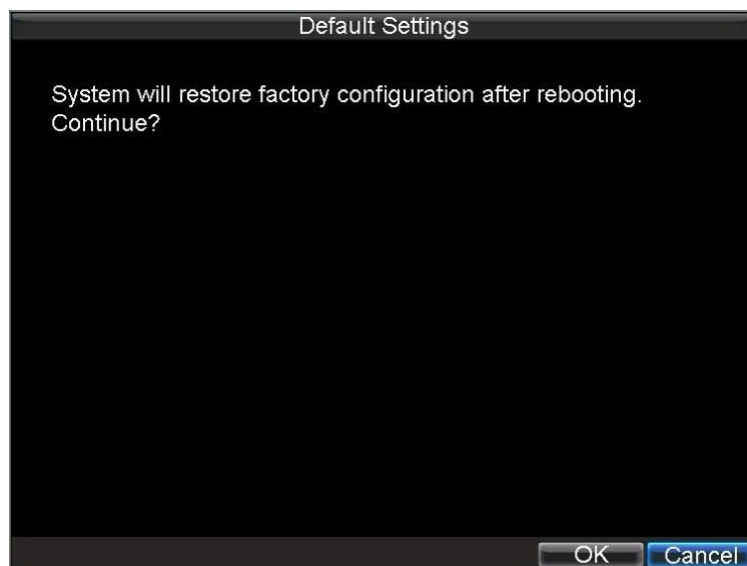

2. Click **OK** to restore the factory default settings.

---

**Note** Network information such as IP address, subnet mask, and gateway will not be restored.

---

---

## Viewing the System Information

---

To view system information:

1. Click **Menu** > **Maintenance** > **Information** to enter the System Information menu (see [Figure 12-14](#)).

**Figure 12-14 System Information**

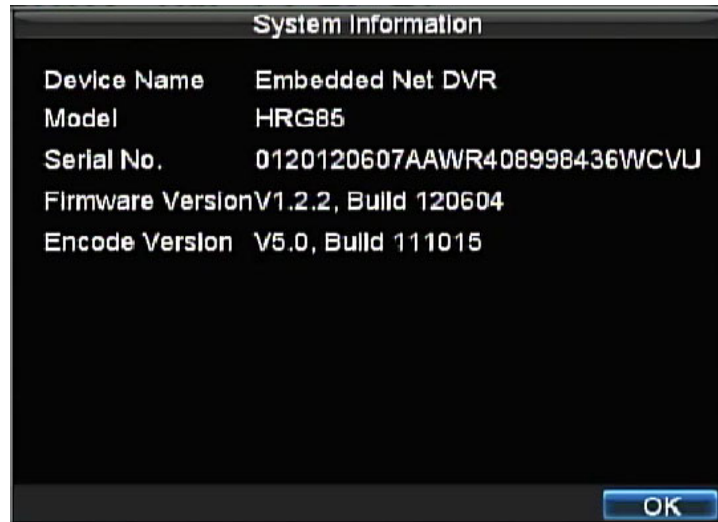

2. Click **OK** to exit to the previous screen.

---

## Viewing the System Log

---

Many DVR events are logged in the system log.

To access the system logs and search for these events:

1. Click **Menu** > **Maintenance** > **Log Search** to enter the Log Search menu (see [Figure 12-15](#)).

Figure 12-15 Log Search Menu

2. Set the search parameters.
3. Click **Search** to start the search.

If logs matching the search conditions are found, they will be displayed in a list of search results (see [Figure 12-16](#)).

Figure 12-16 Log Search Results

Major Type	Start Time	Minor Type	Parameter
Informatic	08-03-2010 08:51:33	HDD S.M.A.R.T	N/A
Informatic	08-03-2010 09:51:38	HDD S.M.A.R.T	N/A
Informatic	08-03-2010 10:51:42	HDD S.M.A.R.T	N/A
Informatic	08-03-2010 11:51:47	HDD S.M.A.R.T	N/A
Informatic	08-03-2010 12:51:46	HDD S.M.A.R.T	N/A
Informatic	08-03-2010 13:51:50	HDD S.M.A.R.T	N/A

4. To view more detailed information about a particular log entry, select the log, and then click **Details**.
5. If applicable, you can also view the associated video to the selected log entry by clicking **Play**.

## Exporting Log Files to a USB Device

Log files can also be exported to a USB device.

To export a log file:

1. Connect a USB device to the HRG DVR.
2. Select the log file to export, and then click **Export** to enter the Log Search Export menu (see [Figure 12-17](#)).

**Figure 12-17 Log Search Export Menu**



3. Click **Export** to export the log onto the USB device.  
The exported file is named based on the time it was exported. For example, *20120911143958logBack.txt*.
4. Click **Cancel** to exit the current menu.





## Glossary

This appendix provides an explanation for commonly used terms in this guide.

**DDNS:** (Dynamic DNS) A method, protocol, or network service that provides the capability for a networked device, such as a router or computer system using the Internet Protocol Suite, to notify a domain name server to change, in real time the active DNS configuration of its configured host names, addresses, or other information stored in DNS.

**DHCP:** (Dynamic Host Configuration Protocol) A network application protocol used by devices (DHCP clients) to obtain configuration information for operation in an Internet Protocol network.

**Dual Stream:** Dual stream is a technology used to record high resolution video locally while transmitting a lower resolution stream over the network. The two streams are generated by the DVR, with the main stream having a maximum resolution of 4CIF and the sub-stream having a maximum resolution of CIF.

**DVR:** (Digital Video Recorder) A DVR is device that is able to accept video signals from analog cameras, compress the signal and store it on its hard drives.

**HDD:** (Hard Disk Drive) A storage medium which stores digitally encoded data on platters with magnetic surfaces.

**HTTP:** (Hypertext Transfer Protocol) A protocol to transfer hypertext request and information between servers and browsers over a network

**Hybrid DVR:** A hybrid DVR is a combination of a DVR and NVR.

**NTP:** (Network Time Protocol) A protocol designed to synchronize the clocks of computers over a network.

**NTSC:** (National Television System Committee) NTSC is an analog television standard used in such countries as the United States and Japan. Each frame of an NTSC signal contains 525 scan lines at 60Hz.

**NVR:** (Network Video Recorder) An NVR can be a PC-based or embedded system used for centralized management and storage for IP cameras, IP Domes and other DVRs.

**PAL:** (Phase Alternating Line) PAL is also another video standard used in broadcast televisions systems in large parts of the world. PAL signal contains 625 scan lines at 50Hz.

**PTZ:** (Pan, Tilt, Zoom) PTZ cameras are motor driven systems that allow the camera to pan left and right, tilt up and down and zoom in and out.

**USB:** (Universal Serial Bus) USB is a plug-and-play serial bus standard to interface devices to a host computer.





## Solutions

This Appendix provides possible solutions for resolving system malfunctions that may occur from time to time.

---

### Troubleshooting the HRG DVR

---

If this happens ...	Try this ...
The DVR makes a beeping sound after booting.	<p>The HRG DVR gives a warning beep after booting if:</p> <ul style="list-style-type: none"><li>• There is no hard drive present in the HRG DVR;</li><li>• The hard drive has not been initialized;</li><li>• The hard drive is defective.</li></ul> <p>If you want to use your HRG DVR without any HDDs, you can disable this warning beep in the Exception Settings menu (See <a href="#">Exception Settings on page 70</a>).</p>
The DVR does not respond to the IR remote control.	<p>After you have read the section <a href="#">Using the IR Remote Control on page 19</a>, check that:</p> <ul style="list-style-type: none"><li>• The batteries are installed correctly in the remote, making sure that the polarities of the batteries are not reversed;</li><li>• The batteries are fresh and not out of power;</li><li>• The remote has not been tampered with;</li><li>• There are no fluorescent lamps in use in close proximity to the HRG DVR.</li></ul>
The PTZ is unresponsive.	<p>Check that:</p> <ul style="list-style-type: none"><li>• The RS-485 cable is properly connected;</li><li>• The PTZ dome decoder type is correct;</li><li>• The PTZ dome decoder speed configuration is correct;</li><li>• The PTZ dome decoder address bit configuration is correct;</li><li>• To make sure that the main board RS-485 interface is not broken.</li></ul>
No video is recorded after setting motion detection.	<p>Check that:</p> <ul style="list-style-type: none"><li>• The recording schedule is set up correctly by following the procedure in <a href="#">Scheduling Recording on page 41</a>;</li><li>• The motion detection area is configured correctly as described in <a href="#">Motion Detection Alarm on page 59</a>;</li><li>• The channels are being triggered for motion detection as described in <a href="#">Motion Detection Alarm on page 59</a>.</li></ul>

**If this happens ...**

The HRG DVR does not detect my USB export device when I try to export recorded files.

**Try this ...**

There is a chance that the HRG DVR and your USB device are not compatible. Please refer to the following list of tested compatible/incompatible USB devices:

**Compatible USB Flash Drives (FAT32)**

- Aigo mini L8202, 1GB (needs to be formatted)
- Aigo Mini MP3-H06 Plus, 128M
- Aigo Mini, 128M
- Babydisk, 64M (manufacturer: Hansol Hedy)
- Caixing, 128M
- CoDisk, 64M
- Crucial, 1G
- DANE-ELEC, 512M
- Imation, 128M
- Kingsoft MD07, 1G
- Kingston Data Traveler, 2GB
- Kingston Data Traveler, 4GB
- Kingston, 1G
- Lexar, 1G
- LG M4, 4G
- Memorex, 1G
- Netac ODF, 64M
- Netac ODN (upgraded), 32M
- Netac OSC 64M, 32M
- Netac U200, 128M
- Newman Flash Disk, 32M
- Newman V3, 2GB
- Newman V6, 1GB
- PNY Attaché, 1G
- PNY attaché, 1G
- RUNDISK RM-UR03, 128M
- Samsung, 64M
- SanDisk, 1G
- Shinco, 1G
- SMART, 128M
- UNiBit, 128M
- Unis Z-301, 4GB

**Incompatible USB Flash Drives (FAT32)**

- Aigo Mini Type Generation II, 1GB
- Aigo Mini Type Generation II, 256M
- Kingsoft MD09, 1G
- Kingsoft MD2007, 1G/2G
- Kingston Data Traveler, 1GB
- Unis Chac USB2.0, 1GB

**Compatible USB HDD (FAT32)**

- Aigo Generation III, 80G
- Aigo Portable Storage H8165, 250G
- Aigo Portable Storage II (Smart Security), 40G
- IBM, 20G/30G
- Lenovo, 80G
- NESO N2501S, 500G
- NESO N2502B, 500G
- NESO N3501B, 1T
- Newman Newsmy, 40G
- Newman Traveller, 2.5T/40G
- Newman YDStar E80, 160G
- OMATA 3.5" Portable HD Enclosure
- PC HD+YDStar Disk Enclosure
- Samsung NM-0704, 160GB
- Seagate FreeAgent Go, 160G
- STYSEN E02 HD Enclosure+Samsung Kinpo 2.5" HD
- YDStar (Sony)+Mobile PC HD
- YDStar Su35 External HD Enclosure plus Seagate 7200.7 80G HD

**Compatible USB R/W**

- Aigo ME-335U2
- Aigo YDStar
- Aigo F5232BU
- ASUS CRW-4824A+YDStar USB Adapter Box
- BenQ (CD/DVD) EW164B
- BENQ 5232WI-ok2
- BENQ EW162I-OK2
- BenQ TW200D
- IMPRESS
- LG GSA-E60N
- LG(CD/DVD) GSA-E10L
- Samsung SE-S204
- Samsung SE-S224
- Samsung(CD/DVD) SE-S164
- Sony+YDStar USB Adapter Box
- Sony CD-R/RW CRX225E+Adapter Cable
- Sony CD-R/RW CRX230AD+Adapter Cable

**Compatible SATA R/W**

- ASUS DRW-22B1ST
- LG GH20NS10
- LG GH22NS50
- LITEON iHAS324-26 Y
- Panasonic SW-9588-C
- Pioneer DVR-212CHG
- Pioneer DVR-217CHG
- Samsung SE-S204
- Samsung SH-S223
- Samsung TS-H653F
- Sony AD-7200S
- Sony AW-G170S

**Compatible IDE R/W**

- ASUS DVD (IDE) DRW-1608P3S
- ASUS DVD (IDE) DRW-1814BL
- ASUS DVD (IDE) RD-W8141LB
- BenQ DVD (IDE) DW1670
- BenQ DVD (IDE) DW1680
- LG CD-R/RW GCE-8525B
- LG DVD (IDE) GSA-H12N
- LG DVD (IDE) GSA-H20L
- LG GH22NP20
- LG GSA-H55N
- NEC DVD R/RW & CD-R/RW ND-3500A
- Samsung DVD (IDE) TS-H652
- Sony CD-R/RW CRX225E
- Sony DVD (IDE) DW-G120A
- Sony DVD (IDE) DW-Q120A
- Toshiba Samsung CD-RW SH-R522
- Toshiba Samsung DVD Writer SH-S182

---

## Troubleshooting the IR Remote Control

---

If this happens ...	Try this ...
The Status indicator does not turn green and there is still no response from the remote.	Check the following: <ul style="list-style-type: none"><li>• Ensure that the batteries are properly installed, and that the polarities of the batteries are not reversed.</li><li>• Ensure that the batteries are fresh and are not out of charge.</li><li>• Ensure that the IR receiver is not obstructed.</li><li>• Ensure that no fluorescent lamp is used nearby.</li></ul>

---





## Specifications

This Appendix provides the specifications for the HRG Performance Series DVRs.

<b>Specifications</b>	
<b>Remote Access</b>	
Sessions Maximum per HRG recorder	24 simultaneous connections: live view, search, playback
Administration: DVR configuration	One at a time
PTZ control	One at a time controlling PTZ
Compatibility	Windows XP, Windows 7 Mobile apps: Apple iPhone <sup>®</sup> , Android
<b>Recorder Unit</b>	
Video Standard	NTSC or PAL software selectable
Color Control	Brightness, contrast, saturation, and hue
Recording and Transmission Compression Algorithm	H.264
Record Mode	(FIFO) Continuous buffer
Recording Capacity	Hard drive capacities up to 1TB
Recording Rate @ 4CIF (Global)	Up to 480 ips (NTSC), model dependant
Video Resolution Settings	Main stream: 4CIF/2CIF/CIF Sub stream: CIF/QCIF
Video Motion Detection	Configurable zone detection area and sensitivity
Event Recording and Reporting	Input via alarm i/p contacts, and motion. Reporting via alarm o/p contact. Email notification.
Removable Media	2 - USB ports
Still Image	JPEG file using Remote Access
Front Panel Control	Intuitive operation supports IR Remote Control and mouse
DHCP Enabled	DHCP or Static IP entry
Port number set-up	Individual entries for Server, HTTP, SMTP
PTZ Protocols Support	Supports multiple PTZ protocols
Language Support	English

<b>Specifications</b>	
<b>Connections</b>	
Video Input	4/8/16, BNC 1 Vp-p @ 75 ohms
Video Output	1 - Composite main monitor, BNC 1 Vp-p @ 75 ohms 1 - VGA Main Monitor 1 - Spot BNC 1 Vp-p @ 75 ohms
Audio Input/Output	Input: 4 channel, line level Output: 1 channel, line level
Sensor Inputs General Purpose	4 inputs (4ch) – terminal block 8 inputs (8ch) – terminal block 16 inputs (16ch) – terminal block
Control Outputs	1 – relay out (4ch); NC/NO terminal block 4 – relay out (8ch/16ch); NC/NO terminal block
Serial Ports	2 – USB (2.0) ports: one on the front panel and another on the rear panel 1 – RS-485 terminal block 1 – RS232
Primary Storage	SATA HDD
Networking	RJ45 10M/100M self-adaptive Ethernet interface
<b>Electrical</b>	
Input Voltage	12 V DC power adapter
Power Consumption	4ch/8ch: 25 W (max) 16ch: 30 W (max)
<b>Mechanical</b>	
Dimensions (W x D x H)	4ch: 12.4 × 9.1 × 1.8 in. (315 × 230 × 45 mm) 8ch/16ch: 17.5 × 11.4 × 1.8 in. (445 × 290 × 45 mm)
Weight	4ch: ≤ 5.7 lbs (≤ 2.6 kg) 8ch/16ch: ≤ 10.1 lbs (≤ 4.6 kg)
Construction	Housing: Steel chassis
<b>Environmental</b>	
Temperature	Operating: 32°F to 104°F (0°C to 55°C) Storage: -22°F to 176°F (-30°C to 80°C)
Relative Humidity	10% to 90%, non-condensing
<b>Regulatory</b>	
Emissions	FCC Part 15B, Class A
Immunity	EN 50130-4:1995+A1:1998+A2:2003
Safety	CSA/UL 60950-1, 2nd Edition



## Dimensions

### 4-Channel HRG

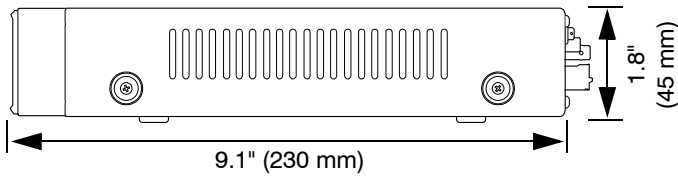
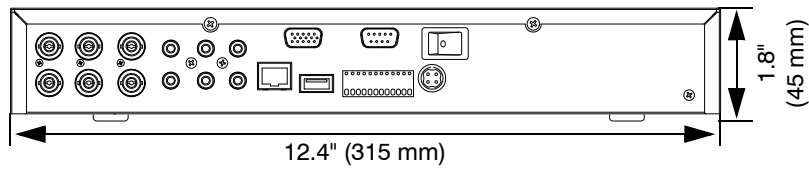

### 8-Channel/16-Channel HRG (HRG16X shown)

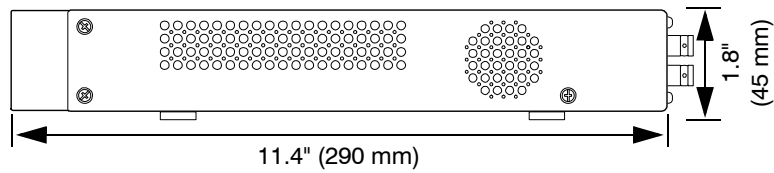
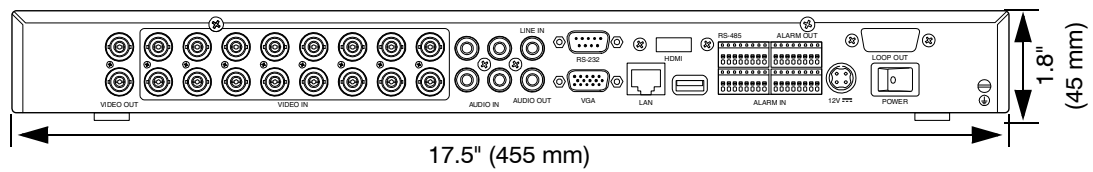



# Index

## A

- admin password, changing [37](#)
- alarms
  - features [25](#)
  - HDD setup [105](#)
  - motion detection [69](#)
  - setting manual triggering [75](#)
  - setting outputs [74](#)
  - setting sensors [72](#)
  - setting video tampering detection [78](#)
- audio, setting [50](#)

## B

- backup
  - features [24](#)
  - managing devices [66](#)
  - recorded files [63](#)
- bit rate, setting [50](#)

## C

- camera
  - multi camera playback [60](#)
  - privacy mask setup [99](#)
  - setting image [98](#)
  - setting OSD [97](#)
- cameras
  - enable motion detection [71](#)
  - setting sequence [47](#)
- Canadian compliance [5](#)
- compliance
  - Canadian [5](#)
- config file, importing/exporting [114](#)
- controls
  - HRG front panel [27](#)
  - HRG8/16 front panel [28](#)
  - playback [58](#)
  - PTZ [93](#)
  - remote control [29](#)
  - USB mouse [30](#)
  - virtual keyboard [31](#)

## D

- date/time, setting [42](#)
- DDNS
  - configuring [86](#)
  - explained [121](#)
- default settings, restoring [117](#)
- device name, setting [109](#)
- device no., setting [109](#)
- DHCP
  - enabling [84](#)
  - explained [121](#)
- digital zoom
  - playback mode [61](#)
  - using in live view [45](#)
- DNS server, setting [84](#)

## E

- exception
  - features [25](#)
  - trigger options [81](#)
- exception settings, configuring [80](#)
- export
  - recorded files [63](#)
  - video clips [65](#)
- exporting
  - config file [114](#)
  - log files [120](#)
  - troubleshooting [124](#)

## F

- features
  - alarm [25](#)
  - backup [24](#)
  - exception [25](#)
  - local monitoring [24](#)
  - network [25](#)
  - overview [23](#)
  - recording [24](#)
- firmware, updating [115](#)
- frame rate, setting [50](#)
- front panel
  - controls, HRG4 [27](#)

controls, HRG8/16 [28](#)

## G

gateway, setting [41](#), [84](#)

## H

### HDD

- alarm setup [105](#)
- compatibility [124](#)
- explained [121](#)
- group setup [102](#)
- initializing [101](#)
- setting to read-only [102](#)
- SMART setup [103](#)
- status [102](#), [103](#)
- troubleshooting [123](#)
- viewing SMART logs [103](#)

### hdd

- alerts [80](#)
- initializing [38](#)
- management features [24](#)
- setting read-only [54](#)

### HRG

- operation timeout [109](#)
- setting device name [109](#)
- setting device no. [109](#)
- system settings [107](#)
- troubleshooting [123](#)

HRG4, rear panel connections [31](#)

HTTP ports, configuring [89](#)

## I

image, setup [98](#)

importing, config file [114](#)

IP address

- setting [41](#), [84](#)
- setting alert [80](#)

## K

keyboard, virtual

- controls [31](#)
- using [31](#)

## L

language, setting [107](#)

live view

- digital zoom [45](#)
- display settings [46](#)
- icons [43](#)
- on-screen display [43](#)
- operating [44](#)
- playback [59](#)
- setting camera sequence [47](#)
- shortcuts [44](#)

using mouse [44](#)

local monitoring features [24](#)

locking the dvr [36](#)

login, first time [37](#)

logs

- exporting files [120](#)
- searching [119](#)
- viewing system [118](#)

## M

manual recording, setting [52](#)

motion detection

- sensitivity [71](#)
- setting area [70](#)
- setting schedule [71](#)

motion detection, alarms [69](#)

mouse

- controls [30](#)
- setting pointer speed [108](#)
- using [30](#)
- using in live view [44](#)

multicast, configuring [88](#)

## N

network

- configuring [83](#)
- configuring settings [41](#)
- disconnected alert [80](#)
- features [25](#)
- HTTP [89](#)
- multicast [88](#)
- remote alarm host [87](#)
- server setup [89](#)
- setting NTP server [86](#)
- setting PPPoE [84](#)
- status [84](#)

NTP

- configuring server [86](#)
- explained [121](#)

## O

OSD, setup [97](#)

## P

password

- changing [37](#)
- enabling/disabling [108](#)
- new user [111](#)
- setting for PPPoE [85](#)

patrols

- clear [95](#)
- PTZ setup [94](#)
- starting/stopping [95](#)

patterns, customizing [96](#)

permissions

- modifying [114](#)
  - setting [111](#), [113](#)
- playback
  - controls [58](#)
  - digital zoom [61](#)
  - exporting video clips [65](#)
  - live view [59](#)
  - multi-camera [60](#)
  - search [58](#)
  - single frame [61](#)
  - system log [60](#)
- PPPoE
  - configuring [84](#)
  - setting password [85](#)
- presets, PTZ setup [93](#)
- privacy mask, setting [99](#)
- PTZ
  - clear patrol [95](#)
  - configuring [92](#)
  - controls [93](#)
  - customizing patterns [96](#)
  - explained [121](#)
  - menu navigation [91](#)
  - menu options [92](#)
  - patrol setup [94](#)
  - preset setup [93](#)
  - starting/stopping patrol [95](#)
  - troubleshooting [123](#)

**R**

- rear panel, HRG4
  - connections [31](#)
- rebooting the dvr [36](#)
- recorded files
  - backing up [63](#)
  - exporting [63](#)
- recorded files, protecting [53](#)
- recording
  - configuring [49](#)
  - features [24](#)
  - initializing [49](#)
  - setting expired time [50](#)
  - setting manual [52](#)
  - setting pre/post record times [50](#)
  - setting schedule [51](#)
- regulatory [5](#)
- related documents [20](#)
- remote alarm host, configuring [87](#)
- remote control
  - configuring [30](#)
  - troubleshooting [125](#)
- remote control controls [29](#)
- resolution
  - setting [50](#)
  - setting VGA [108](#)
- rs-232, setting [109](#)

**S**

- safety instructions [6](#)
- schedule
  - copying [40](#)
  - setting [40](#)
  - setting motion detection [71](#)
  - setting recording [51](#)
  - setting video loss detection [77](#)
- search, playback [58](#)
- sensor alarms, setting [72](#)
- server, configuring [89](#)
- setting [108](#)
- setup wizard, using [36](#)
- shutting down the dvr [36](#)
- starting the dvr [35](#)
- subnet mask, setting [41](#), [84](#)
- system diagram [26](#)
- system firmware, updating [115](#)
- system log, viewing [118](#)
- system settings [107](#)
- system time [108](#)

**T**

- time zone, setting [108](#)
- time, system setup [108](#)
- timeout, setting [109](#)

**U**

- user
  - adding [110](#)
  - deleting [113](#)
  - modifying [114](#)
  - setting password/permissions [111](#)
- user accounts, managing [110](#)

**V**

- video
  - exporting clips [65](#)
  - live view playback [59](#)
  - multi-camera playback [60](#)
  - playback [57](#)
  - playback search [58](#)
  - quality setup [50](#)
  - single frame playback [61](#)
  - system log playback [60](#)
- video loss detection, scheduling [77](#)
- video tampering detection, setting [78](#)

**W**

- warranty [7](#)
- WEEE [6](#)

**Z**

- zoom

live view [45](#)  
playback [61](#)

PTZ [93](#)



**Honeywell Systems (Head Office)**

2700 Blankenbaker Pkwy, Suite 150  
Louisville, KY 40299, USA  
[www.honeywellvideo.com](http://www.honeywellvideo.com)  
☎ +1.800.796.2288

**Honeywell Security Europe/South Africa**

Aston Fields Road, Whitehouse Industrial Estate  
Runcorn, WA7 3DL, United Kingdom  
[www.honeywell.com/security/uk](http://www.honeywell.com/security/uk)  
☎ +44.01928.754028

**Honeywell Security Caribbean/Latin America**

9315 NW 112th Ave.  
Miami, FL 33178, USA  
[www.honeywellvideo.com](http://www.honeywellvideo.com)  
☎ +1.305.805.8188

**Honeywell Security Pacific**

Level 3, 2 Richardson Place  
North Ryde, NSW 2113, Australia  
[www.honeywellsecurity.com.au](http://www.honeywellsecurity.com.au)  
☎ +61.2.9353.7000

**Honeywell Security Asia**

35F Tower A, City Center, 100 Zun Yi Road  
Shanghai 200051, China  
[www.asia.security.honeywell.com](http://www.asia.security.honeywell.com)  
☎ +86 21.5257.4568

**Honeywell Security Middle East/N. Africa**

Post Office Box 18530  
LOB Building 08, Office 199  
Jebel Ali, Dubai, United Arab Emirates  
[www.honeywell.com/security/me](http://www.honeywell.com/security/me)  
☎ +971.04.881.5506

**Honeywell Security Northern Europe**

Ampèrestraat 41  
1446 TR Purmerend, The Netherlands  
[www.honeywell.com/security/nl](http://www.honeywell.com/security/nl)  
☎ +31.299.410.200

**Honeywell Security Deutschland**

Johannes-Mauthe-Straße 14  
D-72458 Albstadt, Germany  
[www.honeywell.com/security/de](http://www.honeywell.com/security/de)  
☎ +49.74 31.8 01.0

**Honeywell Security France**

Immeuble Lavoisier  
Parc de Haute Technologie  
3-7 rue Georges Besse  
92160 Antony, France  
[www.honeywell.com/security/fr](http://www.honeywell.com/security/fr)  
☎ +33.(0).1.40.96.20.50

**Honeywell Security Italia SpA**

Via della Resistenza 53/59  
20090 Buccinasco  
Milan, Italy  
[www.honeywell.com/security/it](http://www.honeywell.com/security/it)  
☎ +39.02.4888.051

**Honeywell Security España**

Avenida de Italia, nº 7, 2ª planta  
C.T.C. Coslada  
28820 Coslada, Madrid, Spain  
[www.honeywell.com/security/es](http://www.honeywell.com/security/es)  
☎ +34.902. 667.800

# Honeywell

[www.honeywellvideo.com](http://www.honeywellvideo.com)  
+1.800.323-4576 (North America only)  
<https://honeywellsystems.com/ss/techsupp/index.html>

Document 800-13897 – Rev A – 01/2013

© 2013 Honeywell International Inc. All rights reserved. No part of this publication may be reproduced by any means without written permission from Honeywells. The information in this publication is believed to be accurate in all respects. However, Honeywell cannot assume responsibility for any consequences resulting from the use thereof. The information contained herein is subject to change without notice. Revisions or new editions to this publication may be issued to incorporate such changes.